



YAMAHA

DVD/Video CD/CD Player

DVD-S796

Operating Instructions



Before connecting, operating or adjusting this product, please read these instructions completely. Please keep this manual for future reference.



Dear Customer

Thank you for purchasing this product.
For optimum performance and safety, please read these instructions carefully.

Accessories

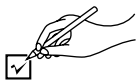

Please check and identify the supplied accessories.



Remote control 1

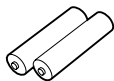

Batteries 2
for remote control

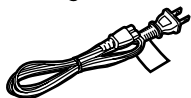

AC power supply cord 1

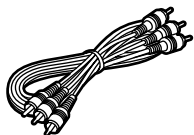

Audio/video cable 1

Note

- The included AC power supply cord is for use with this unit only. Do not use it with other equipment.

User memo:

DATE OF PURCHASE _____
DEALER NAME _____
DEALER ADDRESS _____
TELEPHONE NUMBER _____

The model number and serial number of this product can be found on either the back or the bottom of the unit.
Please note them in the space provided below and keep for future reference.

MODEL NUMBER _____
SERIAL NUMBER _____

Table of contents

Getting Started

Accessories	2
SAFETY INFORMATION	3
Remote control preparations	5
Disc information	6
Control reference guide	7
Home theater	8
Connecting an AV amplifier with a built-in decoder	9
Connecting audio equipment with 2-channel analog audio input terminals	10
Connecting audio equipment with digital audio input terminals	11
Connection to a television	12

Basic Operations

Basic play	14
Stopping play	15
Other methods of play	16
Still picture (Pause)	16
Skipping chapters or tracks	16
Frame advance (Frame reverse)	16
Slow-motion play	17
Rapid advance (Rapid reverse)	17
Canceling playback control	18
Using menus to play	18

Advanced Operations

Advanced operations	19
Changing soundtrack	19
Changing subtitle language	20
Viewing from another angle	20
Reproducing an Advanced Virtual Surround Sound (V.S.S.) effect	21
Repeat play	22
Repeating sections between two specific points (A-B repeat)	22
Program play	23
Random play	24
Using On-Screen Menu Icons	25
Common procedures	25
Detailed descriptions of each icon	26
Changing initial settings	28
Common procedures	28
1 Disc Languages	29
2 Ratings	30
3 Menu Language	31
4 On-Screen Messages	31
5 FL Display	31
6 TV Aspect	31
7 Digital Audio Output	32
9 Other Settings	34
How different kinds of software appear on your television	35

For Your Reference

Troubleshooting Guide	36
Disc handling	38
Maintenance	38
Specifications	39

SAFETY INFORMATION

Note

Use this player only in areas with the same power supply.
Units for the U.S.A. and Canada: AC 120 V, 60 Hz.

CAUTION:

DVD/VIDEO CD/CD PLAYER IS A CLASS I LASER PRODUCT. HOWEVER THIS DVD/VIDEO CD/CD PLAYER USES A VISIBLE LASER BEAM WHICH COULD CAUSE HAZARDOUS RADIATION EXPOSURE IF DIRECTED. BE SURE TO OPERATE THE DVD/VIDEO CD/CD PLAYER CORRECTLY AS INSTRUCTED.

WHEN THIS DVD/VIDEO CD/CD PLAYER IS PLUGGED TO THE WALL OUTLET, DO NOT PLACE YOUR EYES CLOSE TO THE OPENING OF THE DISC TRAY AND OTHER OPENINGS TO LOOK INTO THE INSIDE OF THIS PLAYER.

USE OF CONTROLS OR ADJUSTMENTS OR PERFORMANCE OF PROCEDURES OTHER THAN THOSE SPECIFIED HEREIN MAY RESULT IN HAZARDOUS RADIATION EXPOSURE.

DO NOT OPEN COVERS AND DO NOT REPAIR YOURSELF. REFER SERVICING TO QUALIFIED PERSONNEL.

WARNING:

TO REDUCE THE RISK OF FIRE OR ELECTRIC SHOCK, DO NOT EXPOSE THIS PLAYER TO RAIN OR MOISTURE.

TO REDUCE THE RISK OF FIRE OR ELECTRIC SHOCK, AND ANNOYING INTERFERENCE, USE THE RECOMMENDED ACCESSORIES ONLY.

This player is not disconnected from the AC power source as long as it is connected to the wall outlet, even if this player itself is turned off. This state is called the standby mode. In this state, this player is designed to consume a very small quantity of power.

FOR CANADIAN CUSTOMERS

To prevent electric shock, match wide blade of plug to wide slot and fully insert.
This Class B digital apparatus complies with Canadian ICES-003.



CAUTION
RISK OF ELECTRIC SHOCK
DO NOT OPEN



CAUTION: TO REDUCE THE RISK OF ELECTRIC SHOCK, DO NOT REMOVE COVER (OR BACK). NO USER-SERVICEABLE PARTS INSIDE. REFER SERVICING TO QUALIFIED SERVICE PERSONNEL.



The lightning flash with arrowhead symbol, within an equilateral triangle, is intended to alert the user to the presence of uninsulated "dangerous voltage" within the product's enclosure that may be of sufficient magnitude to constitute a risk of electric shock to persons.



The exclamation point within an equilateral triangle is intended to alert the user to the presence of important operating and maintenance (servicing) instructions in the literature accompanying the appliance.

CAUTION	-LASER RADIATION WHEN OPEN. DO NOT STARE INTO BEAM.
ATTENTION	-RAYONNEMENT LASER EN CAS D'OUVERTURE. NE PAS REGARDER DANS LE FAISCEAU.
VORSICHT	-LASERSTRAHLUNG, WENN ABDECKUNG GEÖFFNET. NICHT IN DEN STRAHL BLICKEN.
ADVARSEL	-LASERSTRÅLING VED ÅBNING. SE IKKE IND I STRÅLEN.
ADVARSEL	-LASERSTRÅLING NÅR DEKSEL ÅPNES. STIRR IKKE INN I STRÅLEN.
VARNING	-LASERSTRÅLNING NÅR DENNA DEL ÄR ÖPPNAD. STIRRA EJ IN I STRÅLEN.
VARO!	-AVATTAESSA OLET ALTIINAN LASERSÄTEILYLLE. ÄLÄ TUJUOTA SÄTEESEEN.
注意	- 当打开这里会出现激光, 请不要直视激光。
注意	- ここを開くとレーザー光が出ます。 レーザー光をのぞき込まないでください。

(Inside of player)

SAFETY INFORMATION

FCC INFORMATION (for US customers only)

- 1. IMPORTANT NOTICE: DO NOT MODIFY THIS UNIT!** This product, when installed as indicated in the instructions contained in this manual, meets FCC requirements. Modifications not expressly approved by Yamaha may void your authority, granted by the FCC, to use the product.
- 2. IMPORTANT:** When connecting this product to accessories and/or another product use only high quality shielded cables. Cable/s supplied with this product **MUST** be used. Follow all installation instructions. Failure to follow instructions could void your FCC authorization to use this product in the USA.
- 3. NOTE:** This product has been tested and found to comply with the requirements listed in FCC Regulations, Part 15 for Class "B" digital devices. Compliance with these requirements provides a reasonable level of assurance that your use of this product in a residential environment will not result in harmful interference with other electronic devices.

This equipment generates/uses radio frequencies and, if not installed and used according to the instructions found in the users manual, may cause interference harmful to the operation of other electronic devices.

Compliance with FCC regulations does not guarantee that interference will not occur in all installations. If this product is found to be the source of interference, which can be determined by turning the unit "OFF" and "ON", please try to eliminate the problem by using one of the following measures:

Relocate either this product or the device that is being affected by the interference.

Utilize power outlets that are on different branch (circuit breaker or fuse) circuits or install AC line filter/s.

In the case of radio or TV interference, relocate/reorient the antenna. If the antenna lead-in is 300 ohm ribbon lead, change the lead-in to coaxial type cable.

If these corrective measures do not produce satisfactory results, please contact the local retailer authorized to distribute this type of product. If you can not locate the appropriate retailer, please contact Yamaha Electronics Corp., U.S.A. 6660 Orangethorpe Ave, Buena Park, CA 90620

The above statements apply **ONLY** to those products distributed by Yamaha Corporation of America or its subsidiaries.

We Want You Listening For A Lifetime

YAMAHA and the Electronic Industries Association's Consumer Electronics Group want you to get the most out of your equipment by playing it at a safe level. One that lets the sound come through loud and clear without annoying blaring or distortion—and, most importantly, without affecting your sensitive hearing. Since hearing damage from loud sounds is often undetectable until it is too late, YAMAHA and the Electronic Industries Association's Consumer Electronics Group recommend you to avoid prolonged exposure from excessive volume levels.

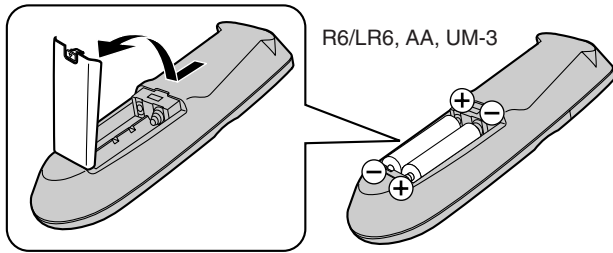
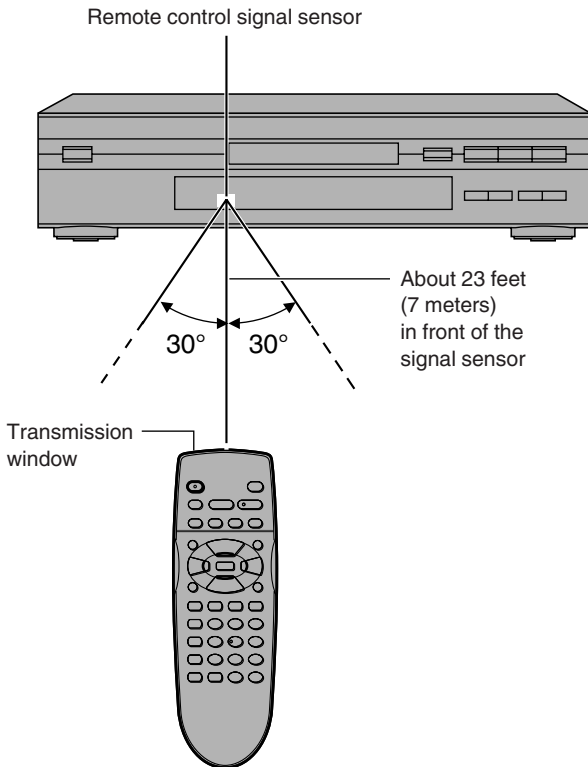

A**B**

Remote control preparations

A Battery installation

Use of batteries

- Align the poles (+ and -) properly when inserting the batteries.
- Do not mix old and new batteries or different types of batteries.
- Do not recharge ordinary dry cell batteries.
- Do not heat or disassemble the batteries. Do not allow them to contact flame or water.
- Remove the batteries if the unit is not to be used for a long time.
- Do not keep together with metallic objects such as necklaces.
- Do not use rechargeable type batteries.
- Do not use batteries if the covering has been peeled off.

Mishandling of batteries can cause electrolyte leakage which can damage items the fluid contacts and may cause a fire. If electrolyte leaks from the batteries, consult your dealer. Wash thoroughly with water if electrolyte comes in contact with any part of your body.





B Correct method of use

Operation notes

- Do not place obstacles between the remote control signal sensor and remote control unit.
- Do not expose the remote control signal sensor to direct sunlight or to the bright light of a fluorescent light.
- Take care to keep the remote control signal sensor and end of the remote control unit free from dust.
- If this system is installed in a rack with glass doors, the glass doors' thickness or color might make it necessary to use the remote control a shorter distance from the system.

To prevent damage

- Never place heavy items on top of the unit.
- Do not disassemble or reconstruct the unit.
- Do not spill water or other liquids into the unit.

 Discs supported by this player		 Discs not supported by this player	
DVD-Video 	3" (8 cm) disc/ 5" (12 cm) disc	<ul style="list-style-type: none"> ● Do not try to play Photo CD or CD-R. (Data on the disc may be damaged.) ● DVD with region number other than "1" or "ALL" ● PAL discs ● DVD-ROM ● DVD-R ● DVD-RW ● SVCD ● CDV etc. 	<ul style="list-style-type: none"> ● Divx Video Disc ● DVD-Audio ● DVD+RW ● CVD ● VSD
Video CD 	3" (8 cm) disc/ 5" (12 cm) disc		
Audio CD 	3" (8 cm) disc/ 5" (12 cm) disc		

For the purpose of these operating instructions, "DVD" stands for DVD-Video and "CD" stands for Audio CD.

■ Region number supported by this player

Region numbers are allocated to DVD players and software according to where they are sold.

- The region number of this player is "1".
- The player will play DVDs marked with labels containing the region number "1" or "ALL".

Example:



■ Playing DVDs and Video CDs

The producer of the material can control how these discs are played. This means that you may not be able to control play of a disc with some operations described in these operating instructions. Read the disc's instructions carefully.

- Example:**
- "⏪" appears when you press the skip buttons to move to the next section.
 - Resume, repeat play, and markers may not work during play of interactive DVDs and menu play of Video CDs with playback control.
 - After showing the Karaoke menu, tracks are played successively without returning to the menu (Video CD with playback control).

■ Marks used in these operating instructions

DVD: indicates features applicable to DVD only.

VCD: Video CD only.

CD: CD only.

■ Terms used in these operating instructions

● Title/Chapter **DVD**

DVDs are divided up into large sections, titles, and smaller sections, chapters. The numbers allocated to these sections are called title numbers and chapter numbers.

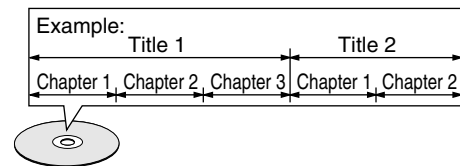

● Track **VCD** **CD**

Video CDs and CDs are divided up into sections called tracks, and the numbers allocated to these sections are called track numbers.

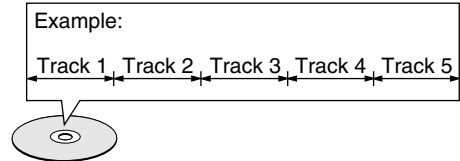

● Playback control **VCD**

If a Video CD has "playback control" written on its disc or jacket, it means that particular scenes or information can be selected for viewing interactively with the TV monitor using the menu screen. This player can play Video CDs with playback control. Using menus to control play of a Video CD is called "menu play" in these operating instructions.

Display during menu play of a Video CD with playback control



● Interactive DVD **DVD**

An interactive DVD is DVD software which includes multiple angles, multiple plot endings, etc. The elapsed play time of some of these DVDs is not shown.

Display during play of an interactive DVD



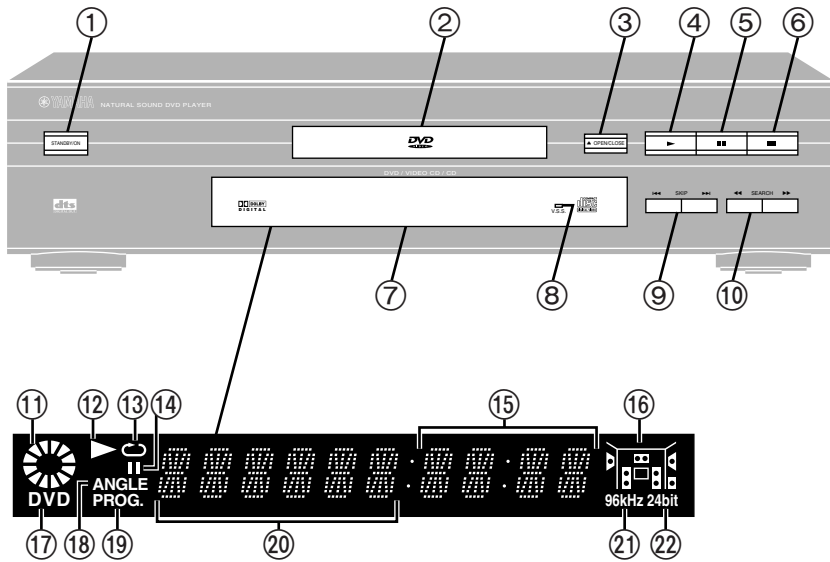

Buttons such as ❶ function in exactly the same way as the buttons on the player.

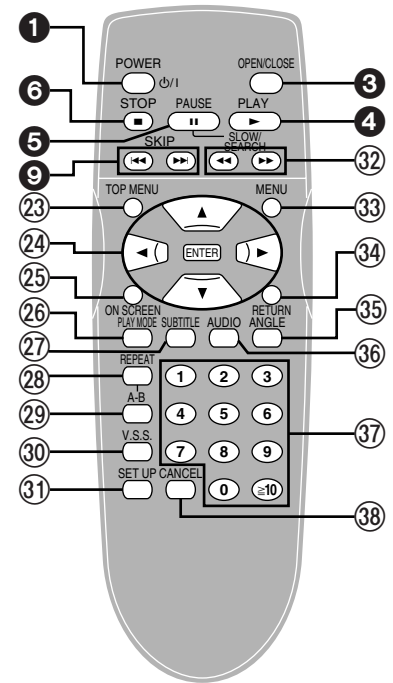

Player

	Page
❶ Standby/On button (STANDBY/ON)	14
Press to switch the unit from on to standby mode or vice versa. In standby mode, the unit is still consuming a small amount of power.	
❷ Disc tray	14
❸ Disc tray open/close button (▲OPEN/CLOSE)	14
❹ Play button (▶)	14
❺ Pause button (⏸)	16
❻ Stop button (■)	15
❼ FL display	
❽ Virtual Surround Sound indicator (V.S.S.)	21
❾ Skip button (⏮ SKIP ⏭)	16
❿ Search button (⏪ SEARCH ⏩)	17
⓫ Rotates during play. Rotates fast clockwise or counterclockwise during rapid advance (reverse). Rotates slowly clockwise or counterclockwise during slow-motion play. DVD VCD	
⓬ Illuminates in the stop mode.	
⓭ Illuminates during playback. Flashes when the RESUME function is ON.	
⓮ Illuminates during repeat play.	
⓯ Illuminates in the still picture (pause) mode.	
⓰ Elapsed playing time from the start of the title/track during play	
⓱ Audio channel information recorded in the disc being played back (e.g. 2ch or 5.1ch)	

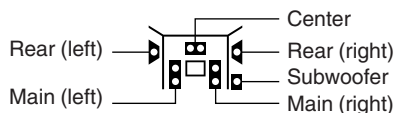

- ⓫ A DVD is loaded.
- ⓬ It is possible to change the angle. **DVD**
- ⓭ Illuminates during program play. **VCD** **CD**
- ⓮ Title/chapter number **DVD**
Track number **VCD** **CD**
- ⓯ Linear PCM of 96 kHz sampling is being played.
- ⓰ Linear PCM of 24 bit is being played.

Remote control

	Page
⓫ Top menu button (TOP MENU)	14
⓬ Cursor buttons (▲, ▼, ◀, ▶)/Enter button (ENTER)	14
⓭ On screen button (ON SCREEN)	25
⓮ Play mode button (PLAY MODE)	23
⓯ Subtitle button (SUBTITLE)	20
⓰ Repeat button (REPEAT)	22
⓱ A-B repeat button (A-B)	22
⓲ Virtual Surround Sound button (V.S.S.)	21
⓳ Setup button (SET UP)	28
⓴ Slow/Search buttons (⏪, ⏩ SLOW/SEARCH)	17
⓵ Menu button (MENU)	14
⓶ Return button (RETURN)	14
⓷ Angle button (ANGLE)	20
⓸ Audio button (AUDIO)	19
⓹ Numeric buttons (1–9, 0, ≥10)	14
•To select a 2-digit number Example: To select track 23 Press [≥10], then [2] and [3].	
⓺ Cancel button (CANCEL)	23

■ Settings for your Home Theater

System	Set up	Equipment to be connected	Speakers	Settings in "7 Digital Audio Output"	Page
To enjoy 5.1 channel surround sound		AV amplifier with digital input and built-in Dolby Digital/DTS decoder	<ul style="list-style-type: none"> ● Main L/R ● Center※2 ● Rear L/R※2 ● Subwoofer※2 	<ol style="list-style-type: none"> 1. PCM down Conversion⇒"Yes" 2. Dolby Digital⇒"Bitstream" 3. DTS⇒"Bitstream" 	9
		AV amplifier with digital input and built-in Dolby Digital decoder (without DTS decoder)	<ul style="list-style-type: none"> ● Main L/R ● Center※2 ● Rear L/R※2 ● Subwoofer※2 	<ol style="list-style-type: none"> 1. PCM down Conversion⇒"Yes" 2. Dolby Digital⇒"Bitstream" 3. DTS⇒"Off" 	9
To enjoy Dolby surround sound※1		AV amplifier with built-in Dolby Pro Logic decoder	<ul style="list-style-type: none"> ● Main L/R ● Center ● Rear L/R 	<ol style="list-style-type: none"> 1. PCM down Conversion⇒"Yes" 2. Dolby Digital⇒"PCM" 3. DTS⇒"Off" 	10
To enjoy linear PCM sound		Stereo amplifier with digital input and built-in high sampling DA converter rated at 96 kHz	Main L/R	<ol style="list-style-type: none"> 1. PCM down Conversion⇒"No" 2. Dolby Digital⇒"PCM" 3. DTS⇒"Off" 	11
		Stereo amplifier with digital input and built-in conventional DA converter	Main L/R	<ol style="list-style-type: none"> 1. PCM down Conversion⇒"Yes" 2. Dolby Digital⇒"PCM" 3. DTS⇒"Off" 	11

※1 If you have connected an AV amplifier with built-in Dolby Pro Logic decoder, you may need to connect center and rear speakers.

※2 Connect speakers if necessary and make the speaker settings on the amplifier.

■ Upgrading your television

- You can connect CRT projectors, LCD projectors, and projection televisions.
- See "Connection to a television" (⇒ pages 12 and 13) for details on connection.

Note

- The equipment connections described are examples.
- Peripheral equipment and optional cables sold separately unless otherwise indicated.

■ Before connections

- Ensure that this player and other equipment to be connected are switched to the standby mode or off and disconnect the AC power supply cord before commencing connection.
- Do not block ventilation holes of any of the equipment and arrange them so that air can circulate freely.
- Read through the instructions before connecting other equipment.
- Ensure that you observe the color coding when connecting audio and video cables.

Note

- TV volume may be lower when playing DVDs than during television broadcasts. Turn the volume up while playing DVDs and reduce it to the previous level **before** switching the source back to television to avoid sudden changes in volume.
- When you have finished connection, select the appropriate screen type at the initial setting "6 TV Aspect" according to your television (4:3/16:9) (⇒ page 31). No changes are needed if you connect the player to a conventional television (4:3).

Conserving power

- The unit consumes approx. 2.0 W even when it is turned off with [STANDBY/ON]. To save power when the unit is not to be used for a long time, unplug it from the household AC outlet.

Connecting an AV amplifier with a built-in decoder

You can enjoy the 5.1-channel surround sound found on DVD recorded with Dolby Digital or DTS Digital Surround by connecting an AV amplifier with a built-in decoder with a built-in decoder or a separate decoder-amplifier combination.

Note when connecting the optical fiber cable

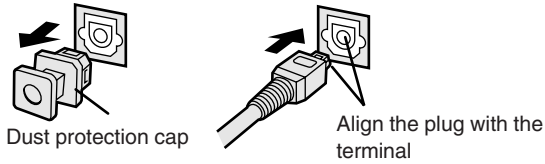

- Remove the dust protection cap from the optical digital audio output terminal and connect the cable firmly so that the configurations of both the cable and the terminal match.
- Keep the dust protection cap and reattach when not using the terminal.

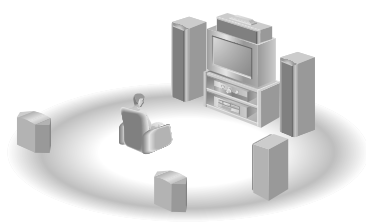
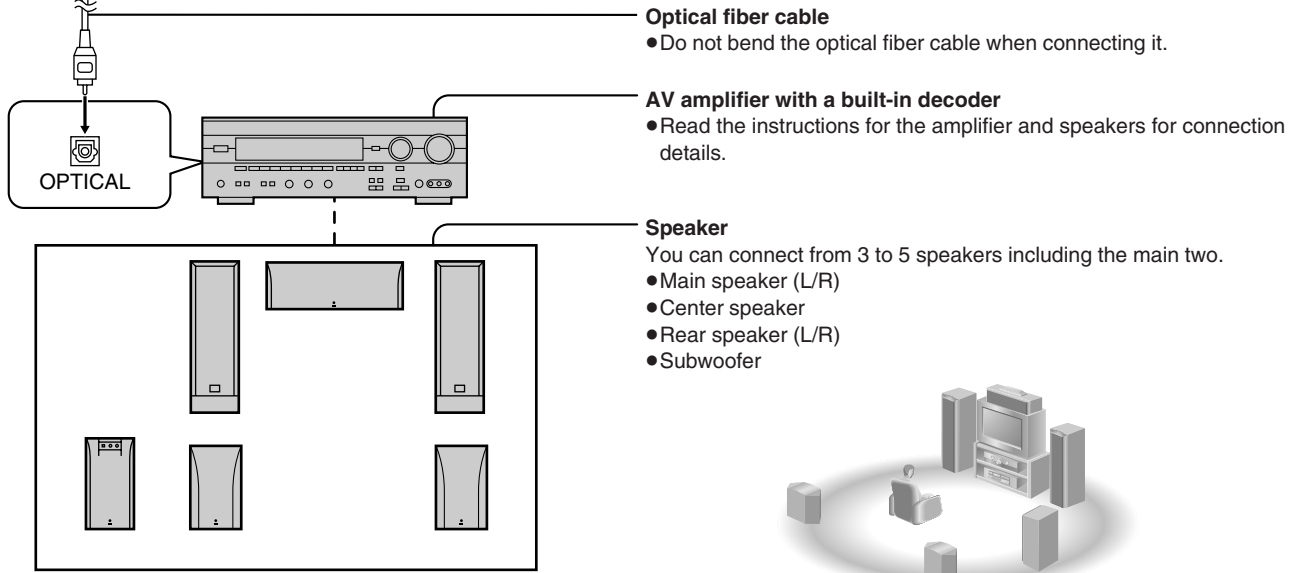
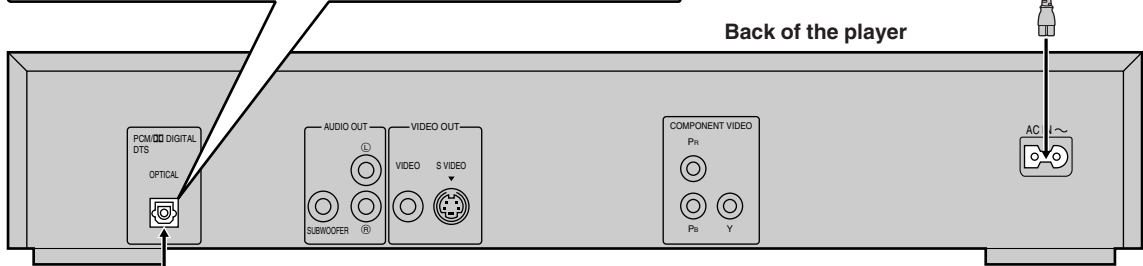
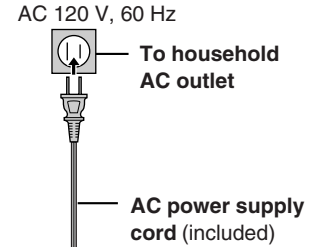

When you have finished connection
Adjust each item of "7 Digital Audio Output" to suit your decoder (➡ page 33).

Connecting audio equipment with 2-channel analog audio input terminals

You can enjoy stereo sound if you connect an amplifier, system component or TV that has 2-channel analog audio input terminals. By connecting a subwoofer, you can also enjoy powerful bass.

■ Connecting the amplifier, system component or TV

Getting Started

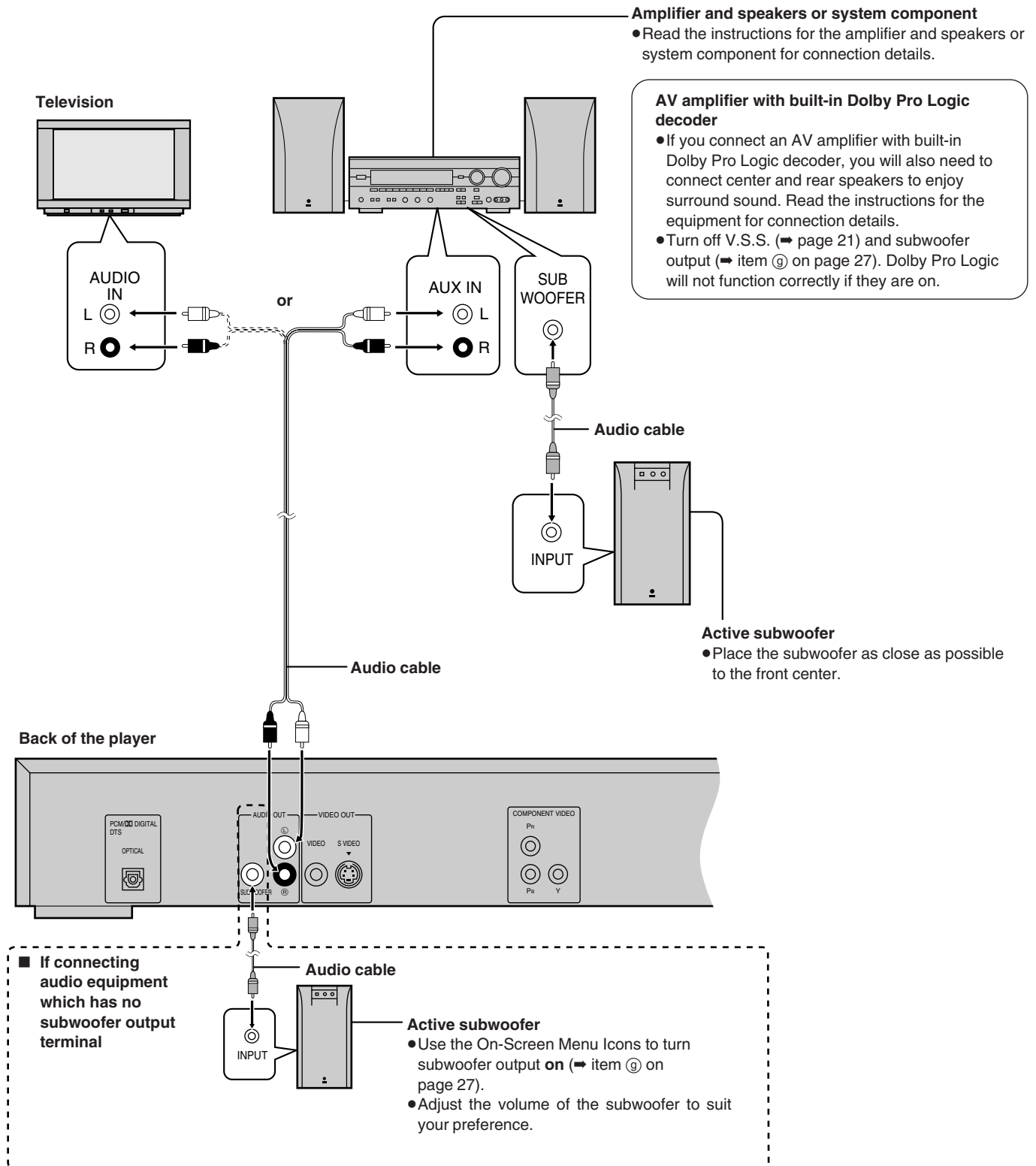

When you have finished connection

Adjust each item of "7 Digital Audio Output" (⇒ page 33).

Connecting audio equipment with digital audio input terminals

Back of the player

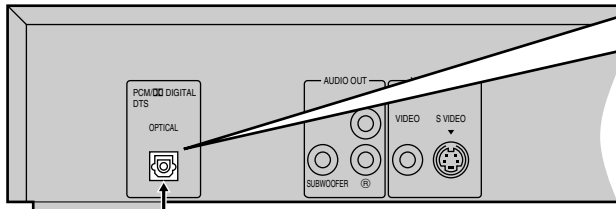

Note when connecting the optical fiber cable

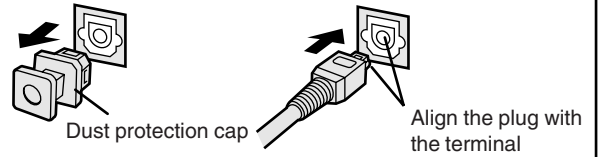

- Remove the dust protection cap from the optical digital audio output terminal and connect the cable firmly so that the configurations of both the cable and the terminal match.
- Keep the dust protection cap and reattach when not using the terminal.

Optical fiber cable

- Do not bend the optical fiber cable when connecting it.

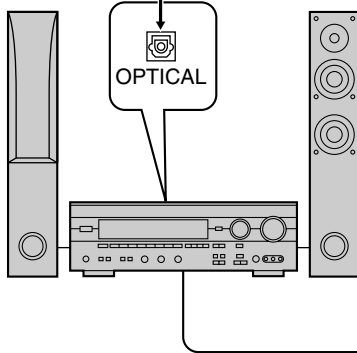

System component or amplifier with digital audio input terminals and speakers

- Read the instructions for the amplifier and speakers or system component for connection details.

When you have finished connection

Adjust each item of "7 Digital Audio Output" (→ page 33).

Connection to a television

Connect Your Player Directly To Your Television.

If the player is connected to the television through a video cassette recorder, the picture may not be played back correctly due to the copy guard. So we strongly recommend you do not connect the player to your video cassette recorder when setting up your home entertainment system.

- Connect to the television section if you connect the player to a combined television-video player.

Do not place the player on amplifiers or other equipment which may become hot.

The heat can damage the player.

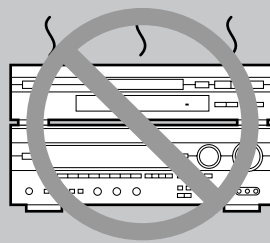

Connecting to a television with video input terminal

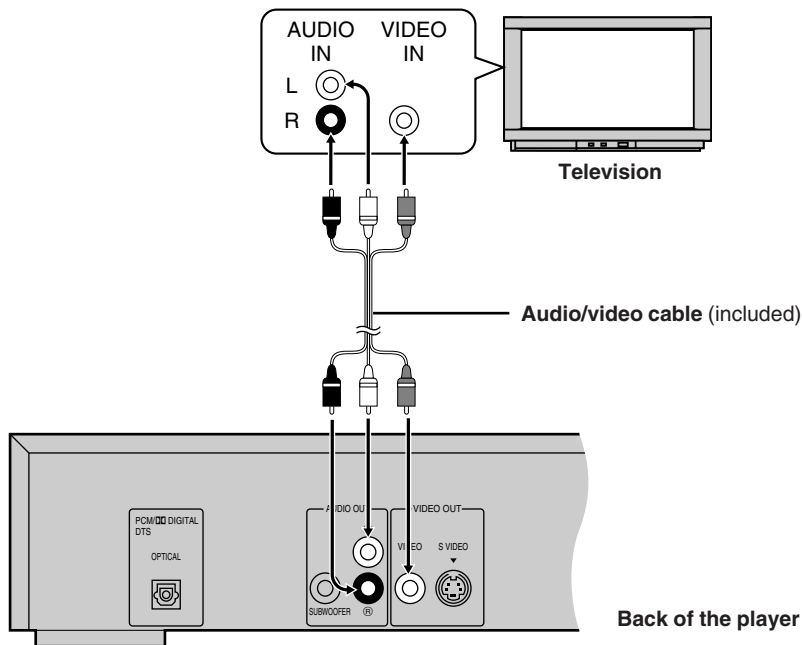

Connecting to a television with S video input terminal

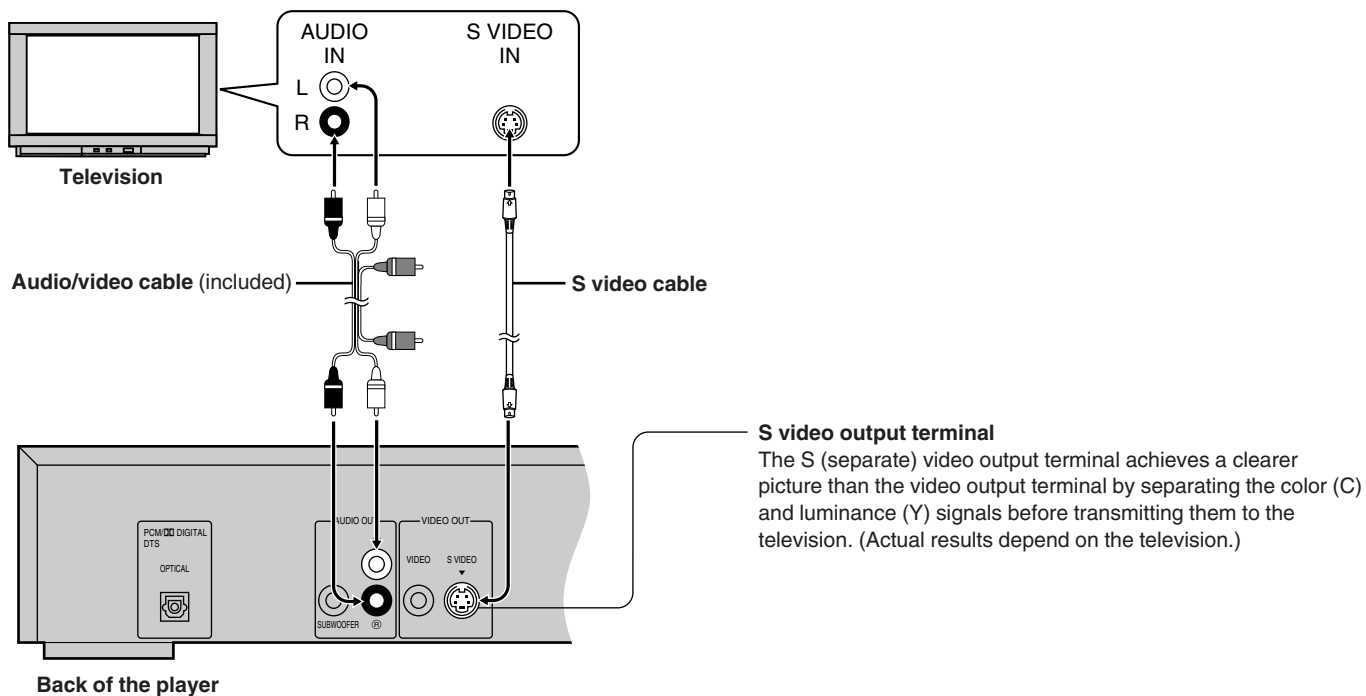

Connecting to a television with component video input terminals

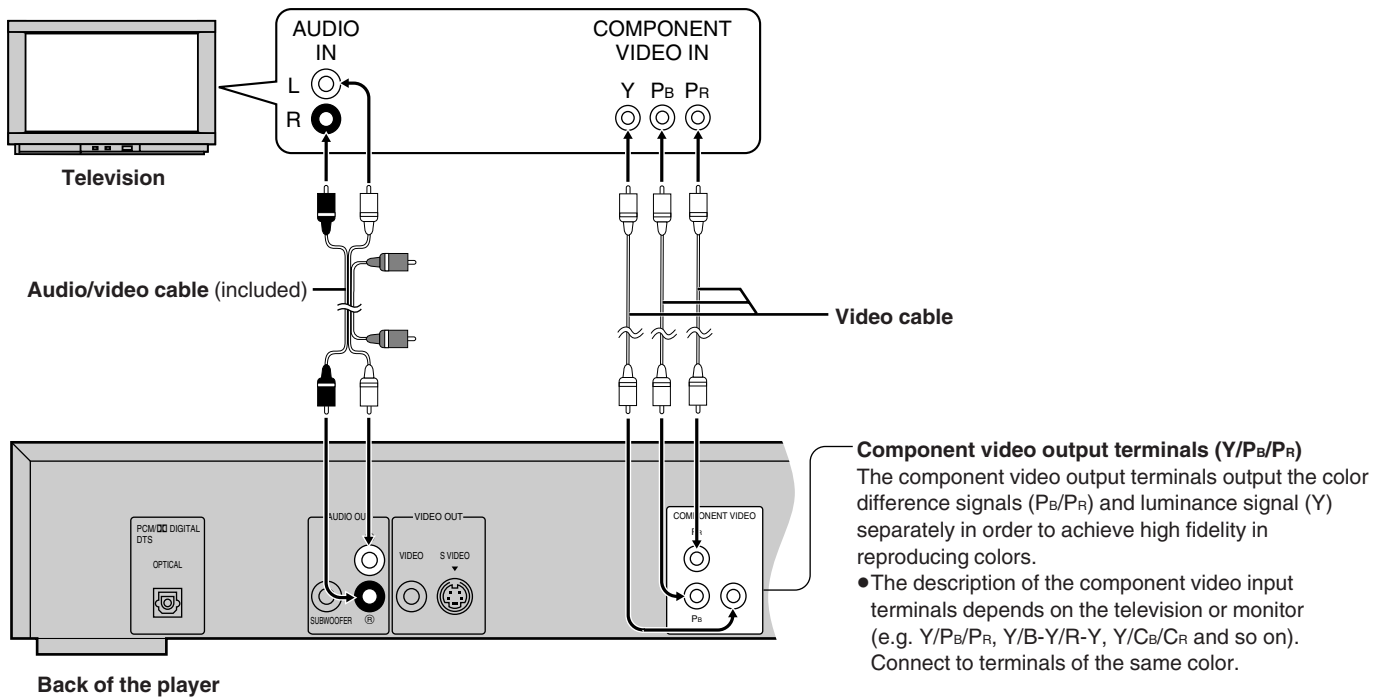

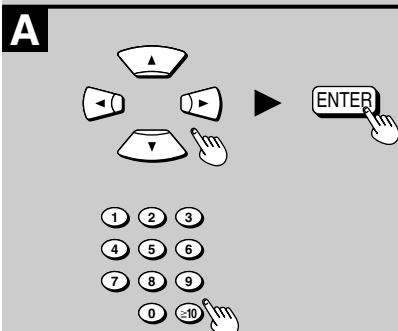
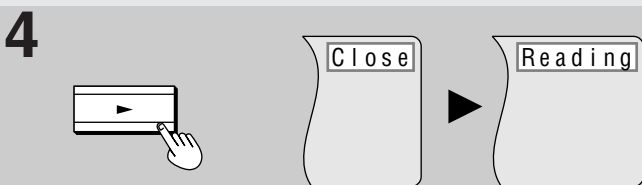
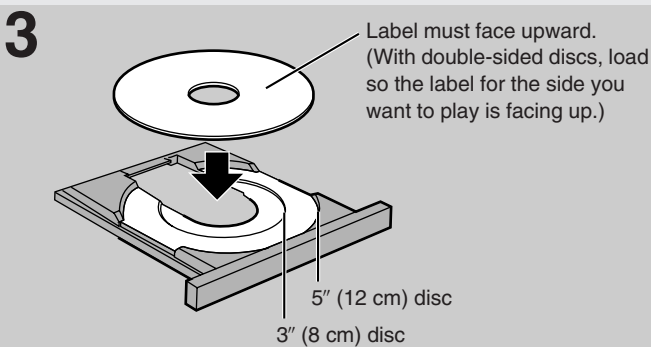
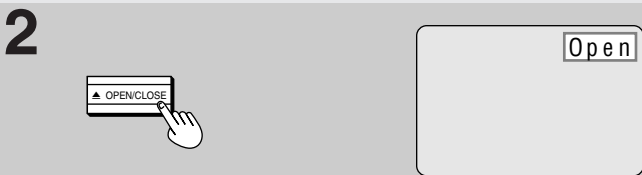
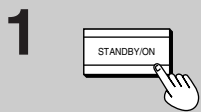
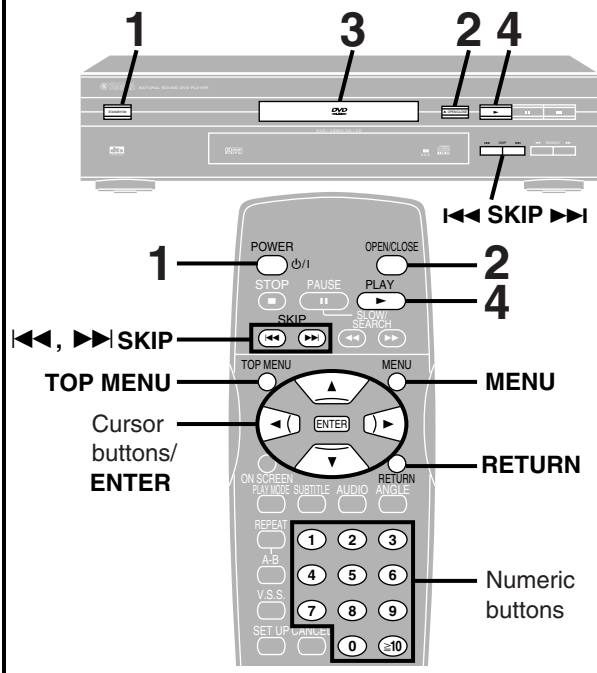

Basic play

■ Before enjoying DVD/Video CD/CD

The menu language for this player has been set to English, but you can change the language to French or Spanish (➡ "3 Menu Language", page 31). English has been used in the examples shown.

Preparations

- Ensure connections to your television and audio equipment are correct.
- Turn on your television and other equipment.
- Switch the video input mode on the television to suit the type of connection you have made (e.g., VCR 2).

1 Press [STANDBY/ON] to switch on the power.

2 Press [▲ OPEN/CLOSE] to open the disc tray.

3 Place the disc on the disc tray.
 • Insert inside the guides.
 • Do not load more than one disc.

4 Press [▶].
 The disc tray is automatically closed and play begins.

A When a menu screen appears on the TV monitor

Press the cursor buttons [▲, ▼, ◀, ▶] and press [ENTER], or press the numeric buttons, to select the item.

Play of the selected item now begins.

- The cursor buttons are not effective for selecting items for Video CDs.

■ Other buttons used to operate menus

Read the disc's instructions for further details about operation.

[▶▶ SKIP]: Shows the next menu.

[◀◀ SKIP]: Shows the previous menu.

[RETURN]: Shows the menu screen.

[TOP MENU]: Shows the first menu screen. **DVD**

[MENU]: Shows the menu screen. **DVD**

Note

- "NO PLAY" is displayed on the FL display if you load the following kinds of discs and they cannot be played:
 - DVD for which playback is prohibited by the initial settings "2 Ratings" (➡ page 30).
 - DVD with a region number other than "1" or "ALL" (➡ page 6).
 - If the disc is put in upside down (and it is a single sided disc).
- When "⊘" appears on the TV monitor when a button is pressed, the operation is prohibited by the player or disc.

STANDBY/ON

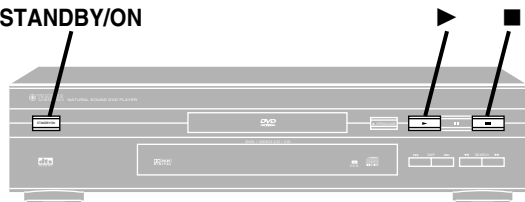

POWER ϕ /I

■ STOP

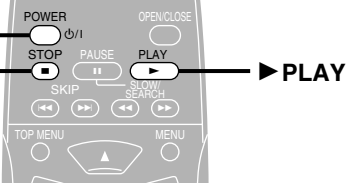

A

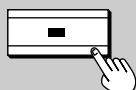

B

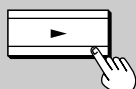

C

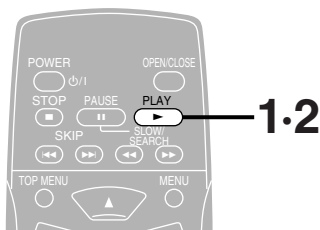
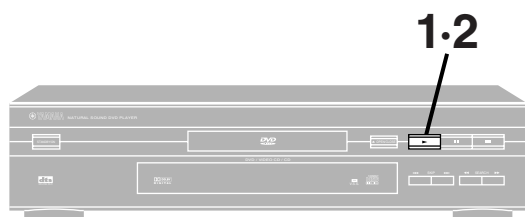

1

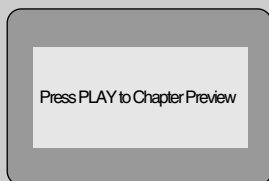
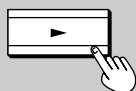

2

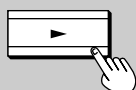

A Stopping play

Press [■] during play.

- The player records the point where [■] was pressed during play. (“▷” flashes on the player’s FL display.)

B To resume play from where you stopped it (RESUME function)

Press [▶] while “▷” is flashing on the FL display. Play will resume from the point where [■] was pressed.

To clear the RESUME function

Press [■] again or open the disc tray while “▷” is flashing on the FL display.

Note

- The RESUME function works only with titles for which the elapsed playing time appears on the player’s FL display during playback.
- This feature remains active if the player is switched to the standby mode and then turned back ON.

C Chapter preview function

DVD

This function plays the first few seconds of each chapter from the beginning of the title up to the point where operation was stopped. This makes it possible to review previous chapters.

1. Press [▶] while “▷” is flashing on the FL display. (The message illustrated is briefly displayed.)
2. Press [▶] again while the message is displayed on the screen.

Normal playback will commence from the point where operation was stopped.

Note

- Canceling the RESUME function will also clear the chapter preview function.
- The chapter preview function may not work with some DVDs.

■ After operation

When the player is not in use, remove the disc and press [STANDBY/ON] to switch the player to the standby mode. The player is automatically switched to the standby mode after 30 minutes or so have elapsed in the stop mode. (Auto power-off function)

Note

- The disc continues to rotate while the menu is displayed even after the player has finished playing a particular item. Stop the player when you finish viewing to preserve the player’s motor and prevent screen burn.

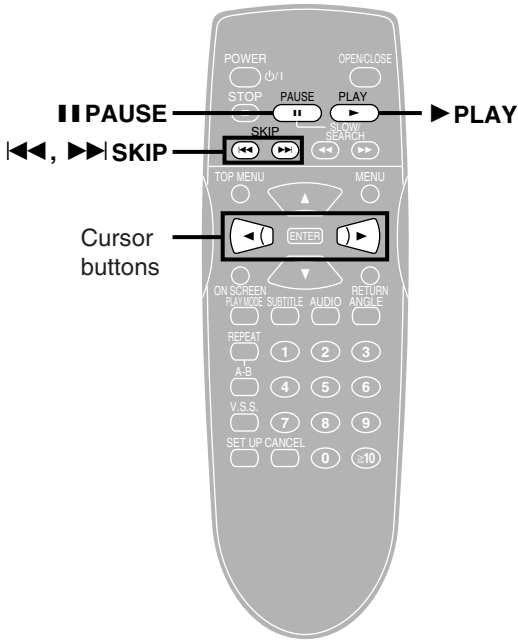
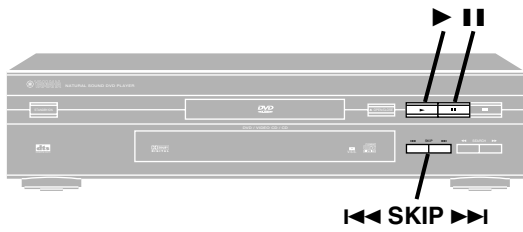

Other methods of play

Features on the next few pages are accessed mainly by using the remote control.

A Still picture (Pause)

Press [|| PAUSE] during play.

To return to normal play

Press [▶ PLAY].

B Skipping chapters or tracks

Press [◀◀, ▶▶ SKIP] or [◀◀ SKIP ▶▶], during play or while paused.

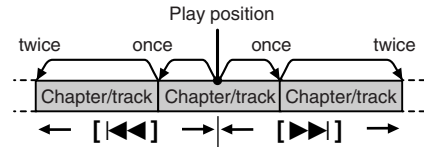

For your reference

- When [◀◀, ▶▶ SKIP] or [◀◀ SKIP ▶▶] on the player is pressed during menu play of Video CDs with playback control, a menu screen may sometimes be recalled.

C Frame advance (Frame reverse)

DVD **VCD**

Press the cursor buttons [◀, ▶] while paused.

- The disc is advanced (reversed) by one frame each time the cursor buttons [◀, ▶] are pressed.
- When the cursor buttons [◀, ▶] are kept pressed, consecutive frame advance (reverse) works.

To return to normal play

Press [▶ PLAY].

For your reference

- Pressing [|| PAUSE] also activates frame advance.
- Whether the pictures are advanced by a “Frame” or “Field” is automatic, but you can change the initial settings to choose how the picture is advanced (➡ page 34).

A

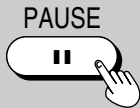

B

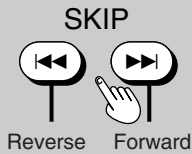

C

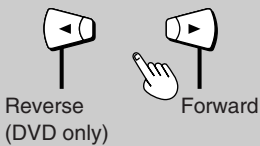

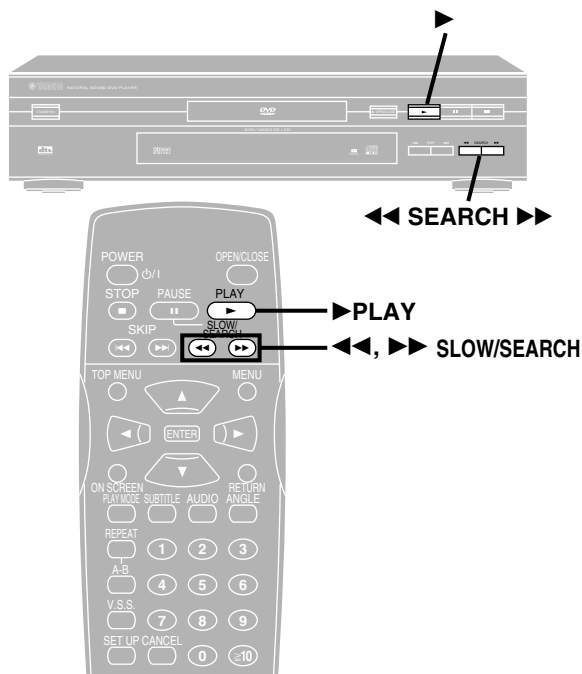

A Slow-motion play

DVD **VCD**

Press [**◀◀, ▶▶ SLOW/SEARCH**] or [**◀◀ SEARCH ▶▶**] while paused (→ page 16).

- Each press increases the speed of slow-motion.

- There are five speeds of slow-motion.

To return to normal play

Press [**▶ PLAY**].

For your reference

- When [**◀◀, ▶▶ SLOW/SEARCH**] or [**◀◀ SEARCH ▶▶**] on the player is pressed during menu play of Video CDs with playback control, a menu screen may sometimes be recalled.

B Rapid advance (Rapid reverse)

Press [**◀◀, ▶▶ SLOW/SEARCH**] or [**◀◀ SEARCH ▶▶**] during play.

- Each press increases the speed of the search.

- There are five speeds of advance (reverse).

To return to normal play

Press [**▶ PLAY**].

For your reference

- When [**◀◀, ▶▶ SLOW/SEARCH**] or [**◀◀ SEARCH ▶▶**] on the player is pressed during menu play of Video CDs with playback control, a menu screen may sometimes be recalled.
- For DVDs and Video CDs, audio will be heard during searching (forward direction only) at the initial search speed. (To turn audio off, → "2 Audio during Search", on page 34.)

A



B



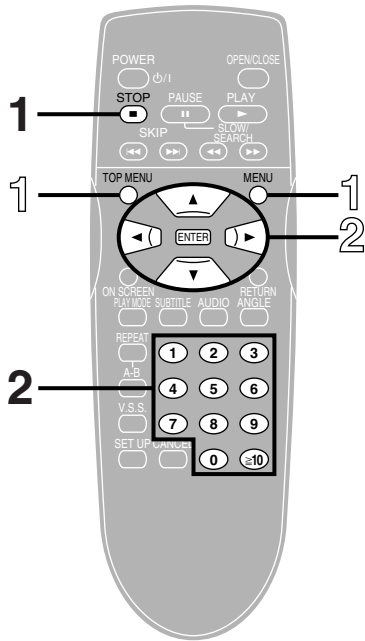

A

1



2

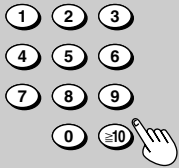

B

1



2

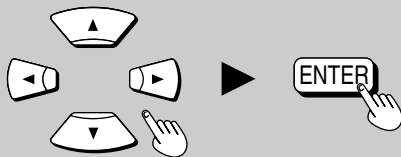

C

Example: if you press the buttons while you are playing title 2

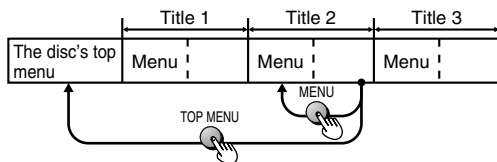

Other methods of play

A Canceling playback control

VCD

1 Press [■ STOP] after the menu screen appears (after step 4 on page 14).
“PBC” will be cleared from the player’s FL display.

2 Press the numeric buttons to select a track (→ item ⑩ on page 7 for number entry).
Play begins.

- Refer to the jacket etc. of the disc concerned for the track numbers.
- Press [1] to start play from the beginning of the disc.

To return to menu play

Press [■ STOP] to stop play, press [MENU], and press the numeric buttons to select an item.
“PBC” lights on the player’s FL display.

B Using menus to play

DVD

By calling up menus during play, you can start play from a specific title or chapter, or change the soundtrack and subtitle languages.

1 Press [TOP MENU] or [MENU] during play to display the menu.
• Press again to return to what you were watching.

2 Press the cursor buttons [▲, ▼, ◀, ▶] to select an item and press [ENTER].

- The selected item is confirmed.
- Repeat if other menus are shown.

DVDs can have several menus. The menu displayed when you press [TOP MENU] may be different to the menu displayed when you press [MENU]. **C**

For your reference

- Menu content depends on the disc. These operating instructions describe the basic steps.
- Both buttons take you to the same menu if the disc has only one menu.

Advanced operations

A

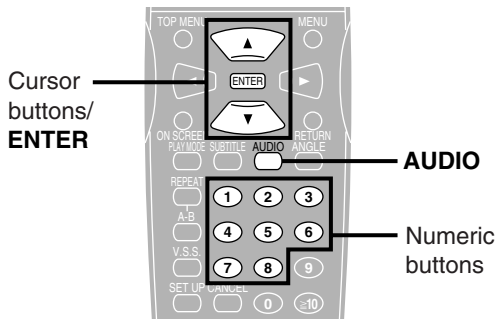

AUDIO



Soundtrack being played back ("—" indicates a soundtrack is not recorded.)

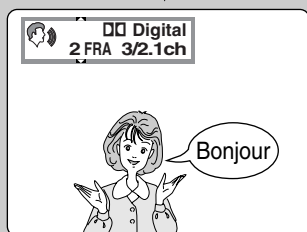
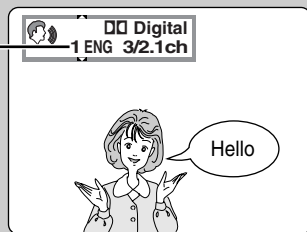

B

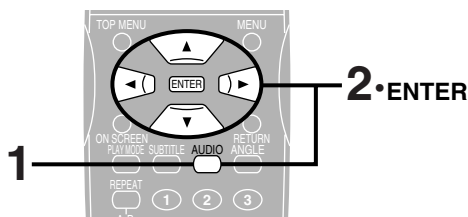

1

AUDIO



2

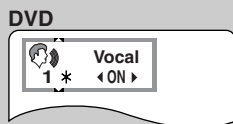
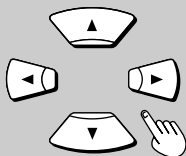

AUDIO

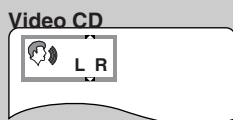

A Changing soundtrack

DVD

Some DVDs have more than one soundtrack recorded on them, and you can change soundtrack during play.

Press [AUDIO] during play to display the current soundtrack.

The number changes each time you press the button.

- You can also use the cursor buttons [▲, ▼], or the numeric buttons to change the soundtrack.

To clear the display

Press [ENTER].

For your reference

- You can only select languages or sound formats if they have been recorded on the disc you are playing.
- If resume (⇨ page 15) is canceled or if you stop play of an interactive DVD, the soundtrack revert to the initial settings. (⇨ page 29)
- Some discs allow changes to soundtrack only by using the disc's menus.

B Switching vocals ON or OFF for Karaoke discs

DVD VCD

1. Press [AUDIO] during play.
2. Press the cursor buttons [▲, ▼, ◀, ▶] or press [AUDIO] to change the setting.

DVD Karaoke [◀, ▶]

- Solo
- Duet
- : Vocal OFF
- : Vocal OFF
- ON: Vocal ON
- 1+2: Vocal 1, 2 ON
- V1: Vocal 1 only ON
- V2: Vocal 2 only ON

- Choose "----" for Karaoke.
- Choose "V1" or "V2" to duet with the player.

Video CD ([▲, ▼] or [AUDIO])

- LR: Vocals (Vocals seem to come from the right)
- L: No Vocals
- R: Vocals (Vocals seem to come from both left and right)
- Choose "L" for Karaoke.

To clear the display

Press [ENTER].

For your reference

- Karaoke discs may show a menu after each track. Some will have a menu that allows you to play all the tracks.
- Some discs require different operations to those described. Read the disc's instructions for details.

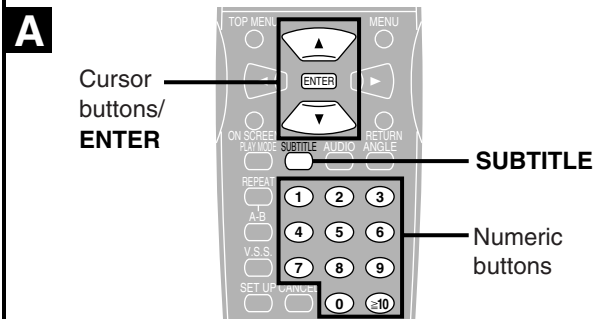
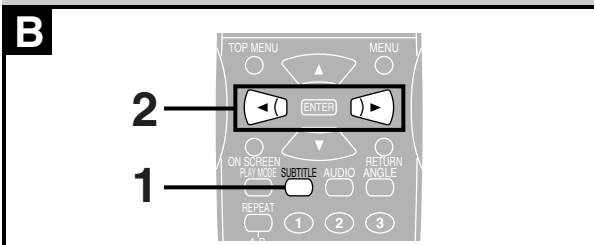
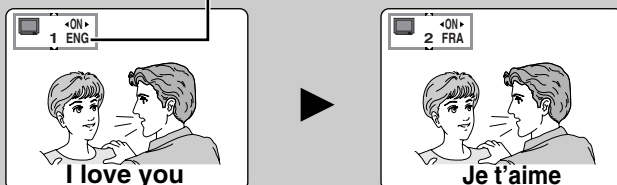
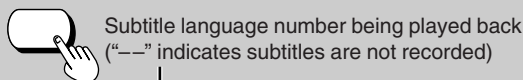
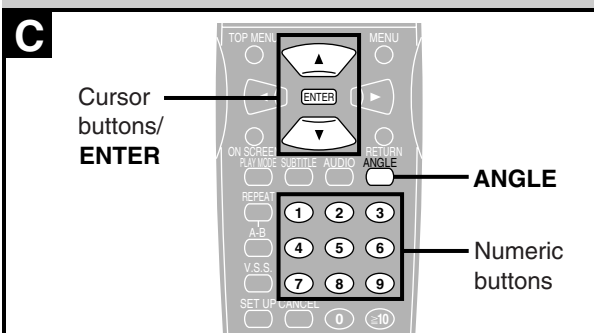
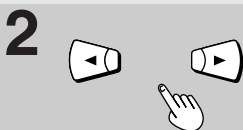
**SUBTITLE****1** SUBTITLE**ANGLE**

Angle number being played back

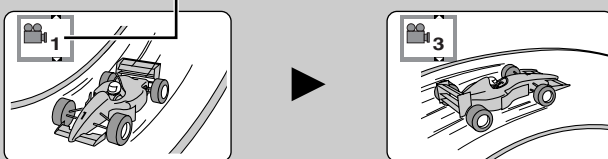

Advanced operations

A Changing subtitle language**DVD**

Some DVDs have more than one subtitle language recorded on them, and you can change subtitle language during play.

Press [SUBTITLE] during play to display the current language number.

The number changes each time you press the button.

- You can also use the cursor buttons [▲, ▼] or the numeric buttons to change the language number.

To clear the display

Press [ENTER].

B To clear/display the subtitles

1. Press [SUBTITLE].
2. Press the cursor buttons [◀, ▶] to select "ON" or "OFF".

Note

- In some cases, the subtitle language is not changed to the selected one immediately.
- When a disc supporting closed captions is played, the subtitles and closed captions may overlap each other on the TV monitor. In this case, turn the subtitles off.

For your reference

- You can only select languages if they have been recorded on the disc you are playing.
- If resume (⇒ page 15) is canceled or if you stop play of an interactive DVD, the subtitle languages revert to the initial settings (⇒ page 29).
- Some discs allow changes to subtitle languages only by using the disc's menus.

C Viewing from another angle**DVD**

Some DVDs allow you to view the same scene from different angles. "ANGLE" lights on the FL display to indicate that the feature is available.

Press [ANGLE] during play to display the current angle number.

The number changes each time you press the button.

- You can also use the cursor buttons [▲, ▼] or the numeric buttons to change the angle.

To clear the display

Press [ENTER].

For your reference

- You can only select angles if they have been recorded on the disc you are playing.
- Some discs allow you to set angles before multi-angle scenes are played.
- Some discs allow changes to angles only by using the disc's menus.

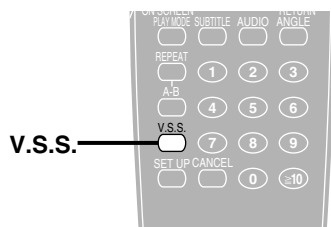
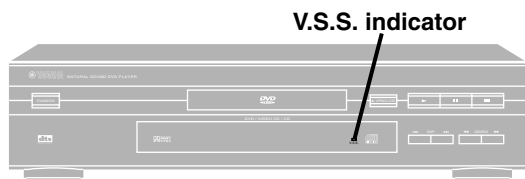

A Reproducing an Advanced Virtual Surround Sound (V.S.S.) effect

DVD (Dolby Digital, 2-channel or over only)

Use this feature to enjoy a surround-like effect if you are using two main speakers.

Press [V.S.S.] during play.

Each time this button is pressed, the player's FL display changes:

- Ⓐ V.S.S. 1 (Natural effect)
- Ⓑ V.S.S. 2 (Emphasized effect)
- Ⓒ V.S.S. is canceled

- The V.S.S. indicator lights up green when the V.S.S. function is activated.

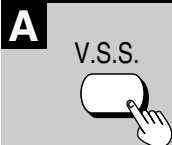

Note

- V.S.S. effect does not work with Karaoke DVDs.
- V.S.S. will not work or will have less effect with some discs.
- Turn off the TV surround sound and other surround sound effects when using this effect.
- Sound will only come from the two main speakers if V.S.S. is on.

B

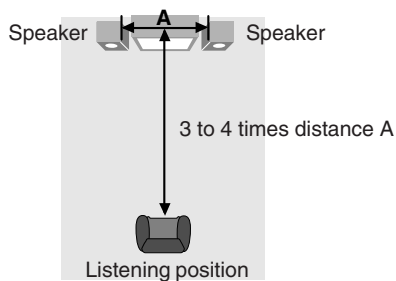

For your reference B

- For optimum effect, it is recommended that the distance between the television and the listening position be about 3 to 4 times the distance between the right and left main speakers.
- You can also change the V.S.S. level with the On-screen Menu Icons [➡ (f) Virtual Surround Sound (V.S.S.)", page 27].

•V.S.S. effects

	V.S.S. 1	V.S.S. 2
Stereo discs	The main speakers sound further apart.	The surround-like effect in V.S.S. 1 is increased.
Surround signal recorded discs	Surround sound seems to come from the side.	

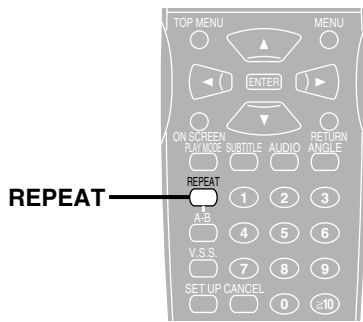

A

REPEAT

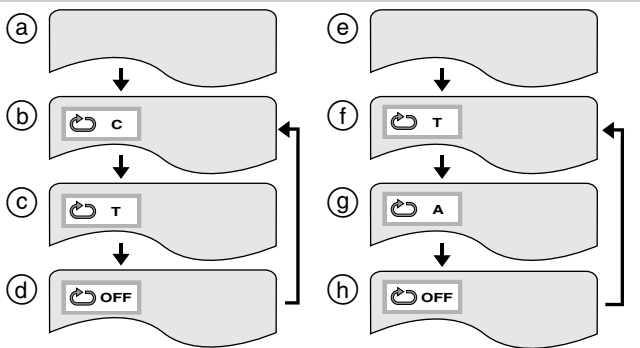

B

REPEAT

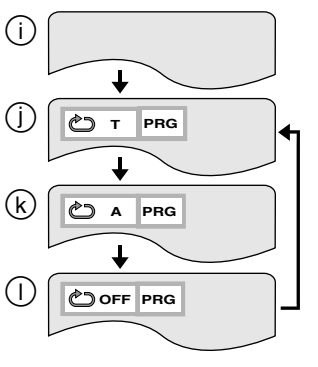

C

1.2

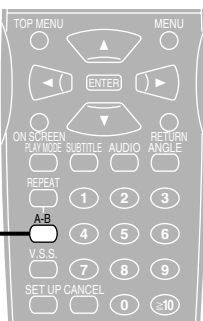

1

A-B



2

A-B



A Repeat play

Press [REPEAT] during play.

Each time this button is pressed, the TV monitor changes as illustrated and the disc will repeat a chapter or title (DVD) or a track (Video CD/CD).

Repeat play starts when the display changes.

•DVD

- a Normal play
- b Repeat of chapter being played
- c Repeat of title being played
- d Cancel repeat mode (Normal play)

•Video CD/CD

- e Normal play
- f Repeat of track being played
- g Repeat of entire disc contents
- h Cancel repeat mode (Normal play)

To return to normal play

Press [REPEAT] until "OFF" is displayed.

Note

- Repeat play may not work correctly with some DVDs.
- Repeat play does not work with an interactive DVD or during menu play of a Video CD with playback control.
- There is no mode for repeating the whole DVD.

B To enjoy program repeat play

VCD CD

If [REPEAT] is pressed during program play (→ page 23), the display changes as illustrated.

- i Program play
- j Repeat of track being played
- k Repeat of all programmed tracks
- l Cancel repeat mode (Program play)

To return to program play

Press [REPEAT] until "OFF" is displayed.

C Repeating sections between two specific points (A-B repeat)

1 Press [A-B] during play at the point where repeat play is to start (A).

2 Press [A-B] at the point where repeat play is to be concluded (B).

Repeat play of the section between points A and B starts.

To return to normal play

Press [A-B] until "••" is displayed.

Note

- A-B repeat play does not work with an interactive DVD.
- Some subtitles recorded around point A or B may fail to appear (DVD).
- A-B repeat play works only within a title (DVD) or a track (Video CD/CD).

For your reference

- The end of a track or title is automatically determined as point B.

Program play

VCD CD

The player plays the tracks on the disc in the order you specify. Up to 32 tracks can be programmed.

If you enter over 32 tracks, the last programmed track is replaced with the new one.

1 Press [PLAY MODE] while stopped until the illustrated screen appears.

- If “⊘” appears on the television, press [■ STOP] to cancel the RESUME function, then press [PLAY MODE].

2 Press the numeric buttons to select the track (⇒ item ①7 on page 7 for number entry). The selected track is stored in memory.

- If you press [ENTER], you can use the cursor buttons [▲, ▼] to select a track. Press [ENTER] to register the track number.
- Repeat step 2 to select another track.

3 Press [▶ PLAY].

Play now begins in the programmed sequence.

To exit the screen

Press [PLAY MODE] twice.

To add tracks

1. Press [■ STOP] twice during program play to show the program play screen.
2. Select the available item with the cursor buttons [▲, ▼], then repeat step 2.

- Press [◀, ▶ SLOW/SEARCH] to turn the pages of the program to make selection quicker.

To return to normal play

1. Press [■ STOP] twice during program play. (Program play is suspended.)
2. Press [PLAY MODE] twice.
3. Press [▶ PLAY].

- The program is retained in memory.

Operation by observing the unit's FL display

- Use the numeric buttons to enter track numbers.
- To check the program, press the cursor buttons [▲, ▼].

Clearing the program

When the program play screen is displayed

• To clear the programmed tracks one by one

Select the track, move to “Clear” with the cursor buttons and press [ENTER].

(Selecting the track and pressing [CANCEL] also clears the programmed track.)

• To clear the whole program

Move to “Clear all” with the cursor buttons and press [ENTER].

(The program is also cleared when the player is switched to the standby mode or turned off, or the disc tray is opened.)

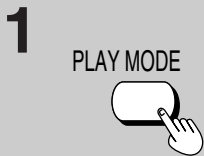
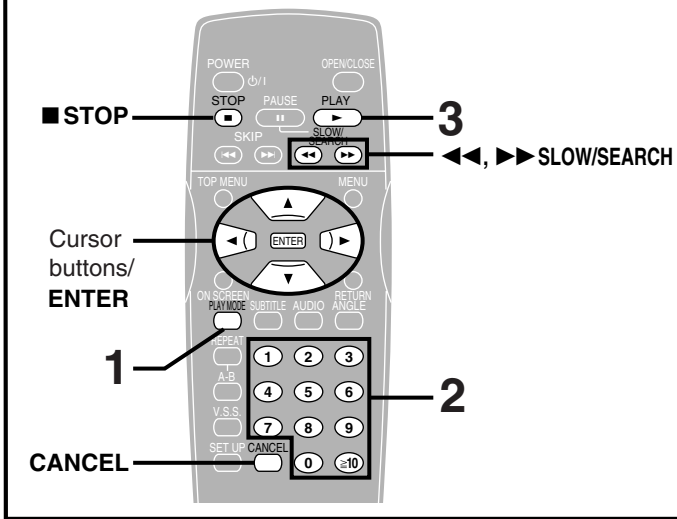

FL display (e.g. CD)

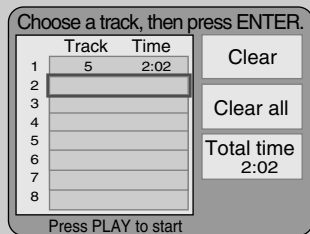
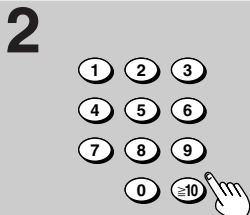
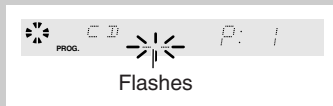

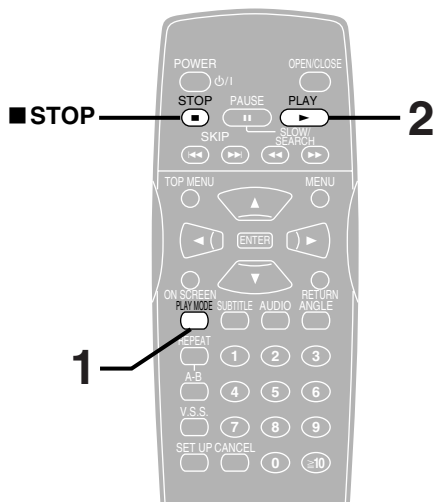

Random play

VCD CD

The player plays the tracks on the disc in random order.

1 Press [PLAY MODE] while stopped until the illustrated screen appears.

- If “⊘” appears on the television, press [■ STOP] to cancel the RESUME function, then press [PLAY MODE].

2 Press [▶ PLAY].

Play now begins in random order.

To exit the screen

Press [PLAY MODE] once.

To return to normal play

1. Press [■ STOP] twice during random play. (Random play is suspended.)
2. Press [PLAY MODE] once.
3. Press [▶ PLAY].

1

PLAY MODE



Random Playback
Press PLAY to start

2

PLAY

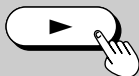

Using On-Screen Menu Icons

On-Screen Menu Icons

On-Screen Menu Icons are long thin menus that contain information about the disc or player. These menus allow you to perform operations by changing this information.

Examples of On-Screen Menu Icons **A**

The screens depend on the disc contents.

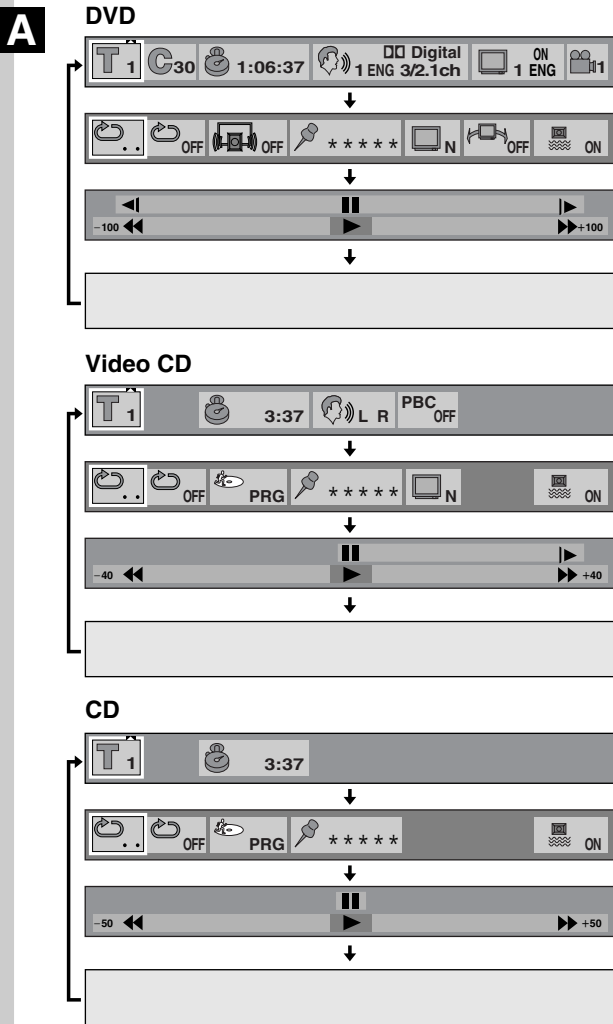

B Common procedures

1 Press [ON SCREEN] during play or in the stop mode.

Each time this button is pressed, the TV monitor changes as shown below.

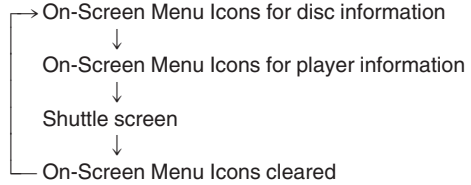

- Some functions cannot be accessed from the stop mode.

2 Press the cursor buttons [◀, ▶] to select the item.

The item is highlighted in yellow.

3 Press the cursor buttons [▲, ▼] to select the setting.

- For some functions, the setting will be registered immediately; for others, [ENTER] or [▶ PLAY] must be pressed.
- When numbers are displayed (e.g. title No.), the numeric buttons are also effective for setting instead of the cursor buttons [▲, ▼]. When numbers are entered with numeric buttons, press [ENTER] to register the setting.

To clear the On-Screen Menu Icons

Press [RETURN] or [CANCEL].

For your reference

- The On-Screen Menu Icons may not be displayed when playing some kinds of DVD software, or if the television's automatic picture zoom function is on. Change the position of the On-Screen Menu Icons in "4 On-Screen Messages" if this occurs (⇒ page 31).
- The color (blue, violet or green) of the On-Screen Menu Icons can be changed (⇒ page 31).
- "▲ ▼" around the icon means that the item can be changed using the cursor buttons [▲, ▼].

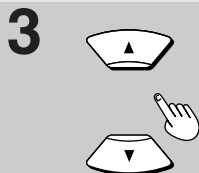
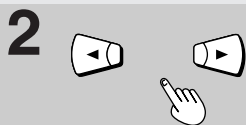
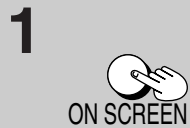
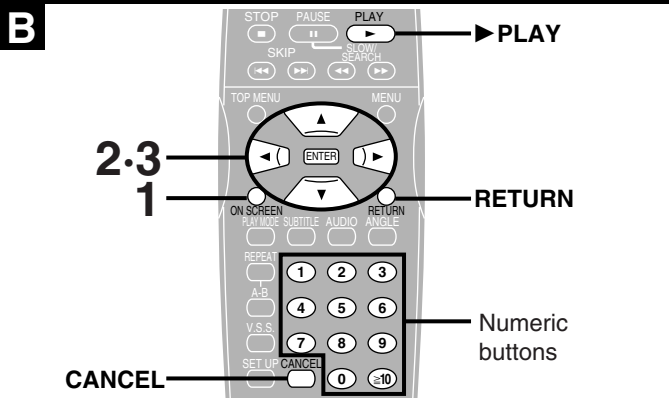

Detailed descriptions of each icon

Screen for disc information

■ DVD

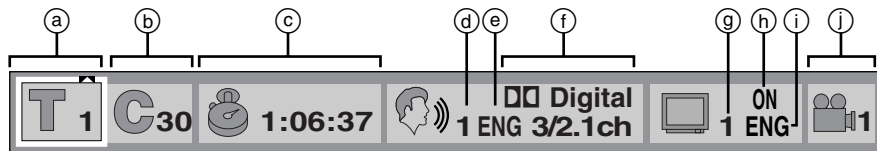

- a **Title No.**
Change the No. with the cursor buttons [▲, ▼] or the numeric buttons and press [ENTER].
- b **Chapter No.**
Change the No. with the cursor buttons [▲, ▼] or the numeric buttons and press [ENTER].
- c **Time**
(hour:minute:second)
Enter the time from which you want to start play and press [ENTER].
Example: To specify "1 hour 6 min. 37 sec.", enter "10637".
- d **Soundtrack No.**
Change the No. with the cursor buttons [▲, ▼] or the numeric buttons.
- e **Soundtrack**

ENG: English	SVE: Swedish	CHI: Chinese
FRA: French	NOR: Norwegian	KOR: Korean
DEU: German	DAN: Danish	MAL: Malay
ITA: Italian	POR: Portuguese	VIE: Vietnamese
ESP: Spanish	RUS: Russian	THA: Thai
NLD: Dutch	JPN: Japanese	*: Others

- f **Audio attribute**
Shows the audio attributes of the selected soundtrack.
LPCM/Digital/DTS: Signal type
k: Sampling frequency (kHz)
b: Number of bits (bit)
ch: Number of channels※
Vocal: Vocals indication
•You can switch vocals ON or OFF with the cursor buttons [▲, ▼].
[DVD Karaoke (Solo)]: --- (OFF) or ON
[DVD Karaoke (Duet)]: --- (OFF), V1+V2, V1 or V2
- g **Subtitle language No.**
Change the No. with the cursor buttons [▲, ▼] or the numeric buttons.
- h **Subtitle on/off**
Select "ON" or "OFF" with the cursor buttons [▲, ▼].
OFF: Subtitle is cleared.
ON: Subtitle is displayed.
- i **Subtitle language**
See the table under item e.
- i **Angle No.**
Change the No. with the cursor buttons [▲, ▼] or the numeric buttons.

■ Video CD/CD

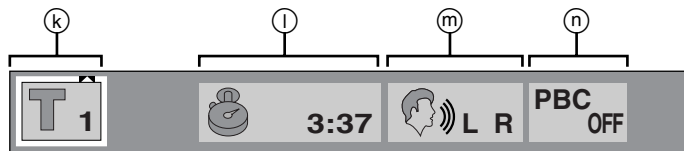

- k **Track No.**
Change the No. with the cursor buttons [▲, ▼] or the numeric buttons and press [ENTER].
- l **Time**
(minute:second)
Display is changed each time the cursor buttons [▲, ▼] are pressed. (The times cannot be changed.)
Elapsed playing time ←————→ Remaining time of the track
↑————→ Remaining time of the disc ←————↑

- m **Audio mode VCD**
Change the mode with the cursor buttons [▲, ▼].
LR: Left channel sound is output from the left speaker (L), and right channel sound is output from the right speaker (R).
L: Left channel sound only is output from the speakers (L/R).
R: Right channel sound only is output from the speakers (L/R).
- n **Playback control VCD**
Shows whether menu play is on or off (cannot be changed here).
OFF: Menu play is OFF.
ON: Menu play is ON.

Note

- The information actually displayed depends on the disc.
- During program and random play of Video CDs and CDs, the remaining time of the disc is not displayed.

※Example:

3/2 .1ch

.1:	Subwoofer signal (not displayed if there is no subwoofer signal)
0:	No surround
1:	Mono surround
2:	Stereo surround (left/right)
1:	Center
2:	Main left+Main right
3:	Main left+Main right+Center

Screen for player information

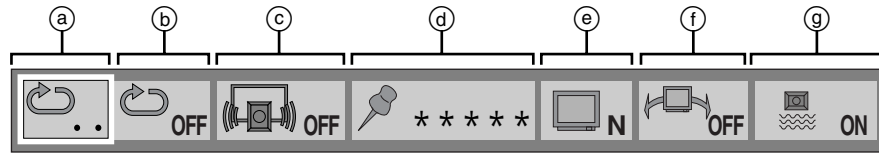

- a A-B repeat play**
Press [ENTER] during play to store location A and press [ENTER] again to store location B. Repeat play between the two locations starts. Press [ENTER] again to return to normal play.
- b Repeat play**
Select the mode during play with the cursor buttons [▲, ▼].

[DVD]	
OFF:	Normal play
C:	Chapter repeat play
T:	Title repeat play

[VCD]	[CD]
OFF:	Normal play
T:	Track repeat play
A:	Disc repeat play
- c Cinema dialogue**

[DVD]	
-------	--

Select the mode during play with the cursor buttons [▲, ▼].

OFF:	Normal volume
ON:	Louder volume for dialogue

Play mode

[VCD]	[CD]	(⇒ pages 23 and 24)
-------	------	---------------------

The current play mode is shown (cannot be changed here).

PRG:	Program play
RND:	Random play
---	Normal play
- d Marker** (Marking parts you want to watch or listen to again)
Press [ENTER] during play and press [ENTER] again at the preferred point to store a marker. (Marker no. replaces “*”). (Up to 5 markers can be stored in the memory.)
To store the next marker, press the cursor button [▶].
 - **To recall a marker**
Select the marker no. with the cursor buttons [◀, ▶] and press [ENTER].
 - **To clear a marker**
Select the marker no. with the cursor buttons [◀, ▶] and press [CANCEL].
 - Some subtitles recorded around the marker may fail to appear.
 - All the markers are cleared when the player is switched to the standby mode or turned off, or the disc tray is opened.
- e Cinema image**

[DVD]	[VCD]
-------	-------

Select the mode with the cursor buttons [▲, ▼] while a disc is loaded.

N:	Normal mode
C:	Cinema mode (Cinema image): Picture for viewing movies
- f Virtual Surround Sound (V.S.S.)**

[DVD]	(Dolby Digital, 2-channel or over only) (⇒ page 21)
-------	---

Select the level during play with the cursor buttons [▲, ▼].

OFF:	V.S.S. off
1:	V.S.S. natural effect
2:	V.S.S. emphasized effect
- g Turning subwoofer output on and off** (⇒ page 10)
Select “ON” or “OFF” with the cursor buttons [▲, ▼].

ON:	If you have connected a subwoofer
OFF:	If you have not connected a subwoofer

Note

- A-B repeat play does not work with an interactive DVD.
- Repeat play and marker functions do not work with an interactive DVD or during menu play of a Video CD with playback control.
- Cinema dialogue is effective with Dolby Digital, three channels or over, where the dialogue is recorded in the center channel.

Shuttle screen

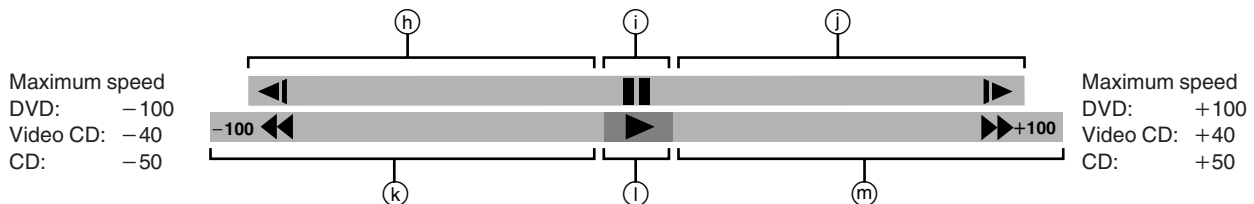

- h Slow-motion play** (Backward) [DVD]
Press the cursor buttons [▲]→[◀].
- i Still/Pause**
Press the cursor button [▲].
- j Slow-motion play** (Forward) [DVD] [VCD]
Press the cursor buttons [▲]→[▶].
- k Rapid reverse**
Press the cursor buttons [▼]→[◀].
- l Play**
Press the cursor button [▼].
- m Rapid advance**
Press the cursor buttons [▼]→[▶].

For your reference

- Each time the cursor buttons [◀, ▶] are pressed, the speed of rapid reverse/advance and slow-motion play increases up to 5 steps.

Changing initial settings

Change the initial settings to suit your preference and to suit the player to the environment in which it is being used.

Common procedures

- 1 Press [SET UP] in the stop mode.**
The initial settings screen is displayed.
- 2 Press the cursor buttons [▲, ▼] to select the item and press [ENTER].**
Each item that can be modified is displayed.

- 1 Disc Languages (⇒ page 29)**
Change the soundtrack language, subtitle language and the language used in the disc's menu to be used for every disc played back.
- 2 Ratings (⇒ page 30)**
Change the ratings level to prevent play of discs, skip violent scenes, or replace scenes with others by entering a password. This is also called a parental lock.
- 3 Menu Language (⇒ page 31)**
Change the language used for the on-screen displays and initial settings menus.
- 4 On-Screen Messages (⇒ page 31)**
Choose whether "Play", "Still" and other displays will be displayed or not, and the color and position of these displays as well as On-Screen Menu Icons.
- 5 FL Display (⇒ page 31)**
Change the brightness for the FL display.
- 6 TV Aspect (⇒ page 31)**
Change the settings to suit the type of television you have connected.
- 7 Digital Audio Output (⇒ page 32)**
Change the settings to suit the type of digital equipment you have connected.
- 9 Other Settings (⇒ page 34)**
Choose the kind of picture shown when play is paused, and various other settings to enhance your viewing experience.

- 3 Press the cursor buttons [▲, ▼] to select the setting and press [ENTER].**
 - Some items require additional steps.
(See the respective page.)Setting is finished and the initial settings screen is displayed.

To cancel during setup operation

Press [RETURN]. (The previous screen is displayed.)

To exit the initial settings screen

Press [SET UP] or [RETURN].

Note

- There is no No. 8 in the initial settings menu of this player.

For your reference

- The numeric buttons can also be used instead of the cursor buttons [▲, ▼] for selecting items or settings. Pressing [ENTER] is not necessary.

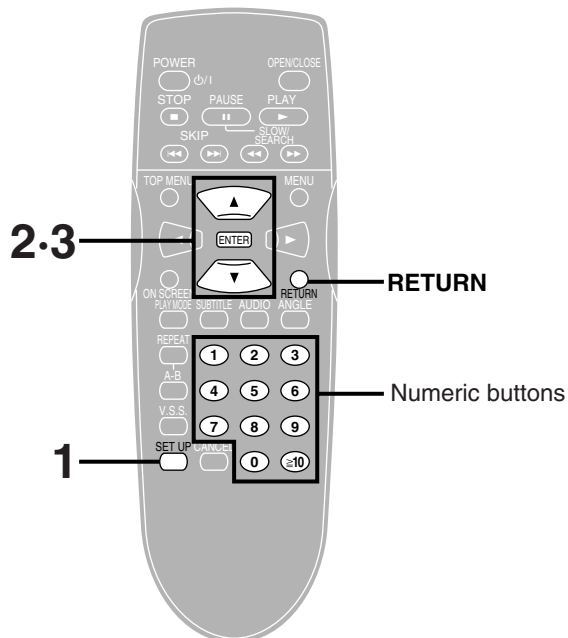

1

SET UP

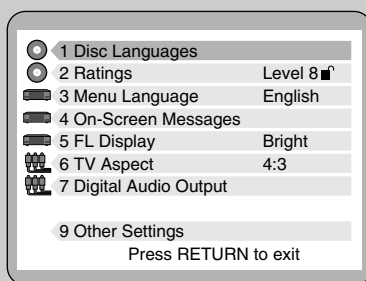

2

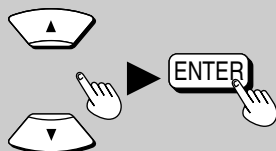

3

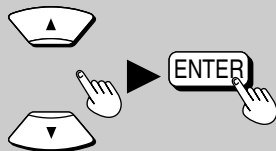

2 Ratings

DVD

See page 28 for operation.

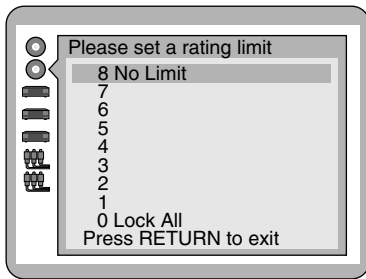

Level 8 (Factory preset)
All DVDs can be played.

Level 7 to 1
Prevents play of DVDs with ratings recorded on them (those that contain adult or violent scenes).

Level 0
Playback of all DVDs is prohibited (e.g. to prohibit playback of DVDs for adults which are not encoded with rating information).

Note

- The rating method differs from disc to disc. There are discs designed for adults that do not have these ratings recorded on them. These discs can be played as normal. To prevent play of these discs, set the rating limit to "0 Lock All".

Setting ratings (When the level is "8")



1 Select the level with the cursor buttons [▲, ▼] and press [ENTER].

2 Enter a 4-digit password with the numeric buttons and press [ENTER].

- Press [CANCEL] if you enter the wrong number.
- The lock symbol appears closed to show the rating is locked.
- Do not forget your password.**

3 Press [ENTER].

Setting is finished and the initial settings screen is displayed.

Now when you insert a DVD that exceeds the ratings limits you set, a message appears on the television. If you want to play the disc, select "Yes" and enter your password. The unit will unlock temporarily, locking again when the disc tray is opened or the unit is turned off.

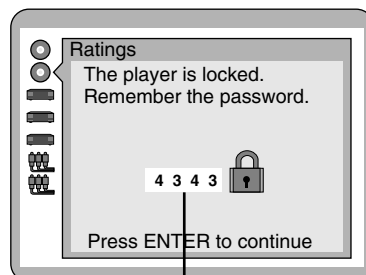
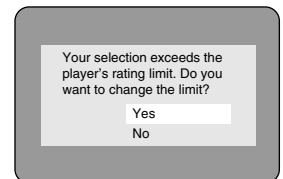

Example: "4343"

Changing ratings (When the level is "0" to "7")

Changes to the settings also requires a password.

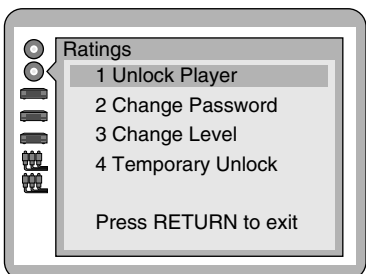

1 Press the cursor buttons [▲, ▼] to select "2 Ratings" in the initial settings screen and press [ENTER].

2 Enter your 4-digit password with the numeric buttons and press [ENTER].

3 Press the cursor buttons [▲, ▼] to select the item.

To unlock the player (the rating level returns to 8)
Select "1" and then press [ENTER].

To change the password
Select "2" and press [ENTER]. Enter a new 4-digit password and press [ENTER], then press [ENTER] again.

To change the rating level
Select "3" and press [ENTER]. Select a new level with the cursor buttons [▲, ▼], then press [ENTER].

To unlock the player temporarily
Select "4" and then press [ENTER].

- The rating is unlocked temporarily for the current disc. The player is locked again when the disc tray is opened or the player is switched to the standby mode or turned off.

3 Menu Language

See page 28 for operation.

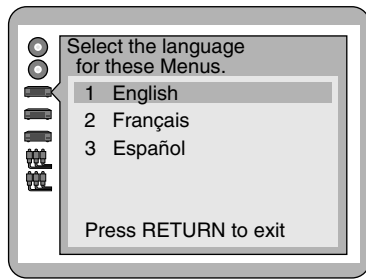

- 1 **English** (Factory preset)
- 2 **Français**
- 3 **Español**

Example: If you selected "2 Français"

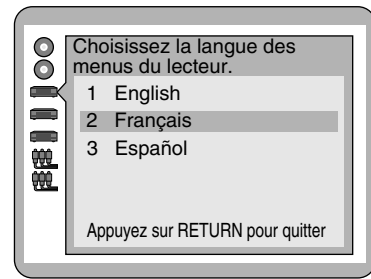

4 On-Screen Messages

See page 28 for operation.

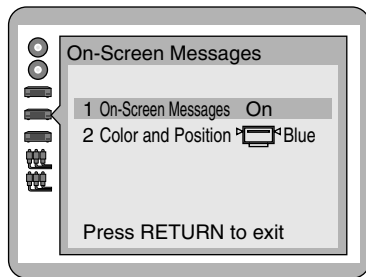

<p>1 On-Screen Messages</p>	<p>1 On (Factory preset) 2 Off</p>
<p>2 Color and Position</p>	<p>1 Blue (Factory preset) 2 Violet 3 Green 4 Blue 5 Violet 6 Green</p> <p style="text-align: right;">} Shown slightly lower. Select if the top of the screen is cut off.</p>

5 FL Display

See page 28 for operation.

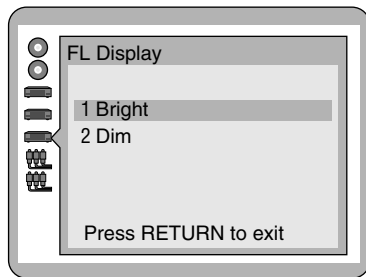

- 1 **Bright** (Factory preset)
- 2 **Dim**

6 TV Aspect

See page 28 for operation.

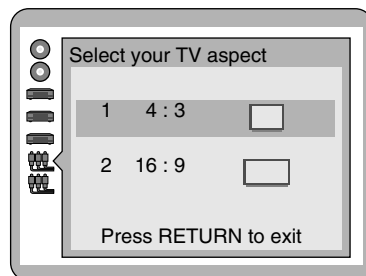

Preparation

- Switch the video input mode on the television to suit the type of connection you have made (e.g., VCR 2).

- 1 **4:3:** (Factory preset)
Select when a conventional television is connected.
- 2 **16:9:**
Select when a wide-screen television is connected.

For your reference

- For further details on the images which appear on the TV screen, see page 35.
- The optimum settings for your television may differ to those shown above.

7 Digital Audio Output

See page 28 for operation.

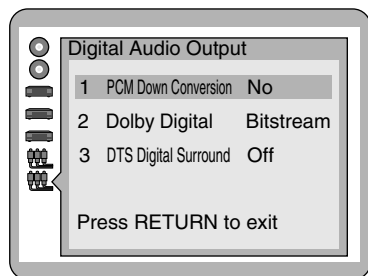

<p>1 PCM Down Conversion^{※1} Select whether to output audio on DVD recorded in 96 kHz linear PCM as it is (No) or to convert it to 48 kHz for output (Yes).</p>	<p>1 No (Factory preset) When playing a DVD recorded in 96 kHz linear PCM, signal of 96 kHz/24 bit sampling frequency will be output and you can enjoy high quality sound. If the DVD is copyright-protected, no digital signal will be output unless converted to 48 kHz. ●Signal of 48 kHz linear PCM can be output from digital audio output terminal irrespective of the setting.</p> <p>2 Yes When playing a DVD recorded in 96 kHz linear PCM, signal is converted to 48 kHz/16 bit and can be output from digital audio output terminal even if the DVD is copyright-protected.</p>
<p>2 Dolby Digital To select the signal format (Bitstream or PCM) to be output from the optical digital audio output terminal during playback of DVDs recorded in Dolby Digital.</p>	<p>1 Bitstream^{※2} (Factory preset) Dolby Digital bitstream (1ch–5.1ch) is output during playback of DVDs recorded in Dolby Digital.</p> <p>2 PCM Digital audio converted to 48 kHz/16 bit PCM (2ch) is output during playback of DVDs recorded in Dolby Digital.</p>
<p>3 DTS Digital Surround To select whether DTS Digital Surround bitstream is output from the optical digital audio output terminal or no digital audio is output during playback of DVDs recorded in DTS Digital Surround.</p>	<p>1 Off (Factory preset) No digital audio is output during playback of DVDs recorded in DTS Digital Surround.</p> <p>2 Bitstream^{※2} DTS Digital Surround bitstream (1ch–5.1ch) is output during playback of DVDs recorded in DTS Digital Surround.</p>

Recommended setting of “Digital Audio Output”

Adjust settings as shown in table below depending on the kind of equipment that is connected to the optical digital audio output terminal.

Type of equipment connected	Recommended setting		
	1 PCM Down Conversion※1	2 Dolby Digital	3 DTS Digital Surround
No digital equipment is connected	<u>No</u>	<u>Bitstream</u>	<u>Off</u>
Dolby Digital decoder (⇒ page 9)	Yes	<u>Bitstream</u>	<u>Off</u>
DTS Digital Surround decoder (⇒ page 9)	Yes	PCM	Bitstream
Dolby Digital/DTS Digital Surround decoder (⇒ page 9)	Yes	<u>Bitstream</u>	Bitstream
Digital audio equipment (no decoder) (⇒ page 11)	Yes	PCM※2	<u>Off</u> ※2

● Underlined items are factory preset.

※1 Select “No” if the digital audio input terminal of your audio equipment (AV amplifier, etc.) can handle 96 kHz/24 bit signal. If it is not acceptable for 96 kHz/24 bit digital audio signal, or the 96 kHz linear PCM disc you want to play is copyright-protected, it is recommended to set “1 No” and make analog connection to enjoy high quality sound (If it is set to “Yes”, the player converts linear PCM to 48 kHz even during analog output).

※2 When connecting an amplifier (with an optical digital input terminal) which does not contain a Dolby Digital or DTS Digital Surround decoder, be sure to select “PCM” at “2 Dolby Digital” and “Off” at “3 DTS Digital Surround”. If “Bitstream” is selected, any attempt to play DVDs (or CDs encoded with DTS) may cause a high level of noise that can injure your ears and damage your speakers.

For your reference

- Dolby Digital is a digital sound compression technique developed by Dolby Laboratories. Supporting 5.1-channel surround sound, as well as stereo (2-channel) sound, this technique enables a large quantity of sound data to be efficiently recorded on a disc.
- DTS Digital Surround is a 5.1-channel surround sound system, which is widely used in movie theaters around the world. The separation between channels is good and provides a very real surround effect.
- Linear PCM is an uncompressed digital audio signal. While a CD is recorded in 44.1 kHz/16 bit, a DVD is recorded in 48 kHz/16 bit up to 96 kHz/24 bit. Therefore, the sound reproduced with these signals is potentially better than that found on CDs. This player reproduces linear PCM in two channels.
- Bitstream is a compressed digital audio signal. This signal can be decoded into different channels to produce, for instance, 5.1-channel surround sound.
- The digital audio output terminal (optical) converts electrical signals into optical signals and transfers them to an amplifier. These optical signals are immune from electrical interference, and they also have minimal effect on other equipment.
- **These changes to digital audio output must be made, otherwise bitstream signals the decoder cannot handle will be output. If these signals are output, “noise” will be output which can cause harm to your ears and speakers.**

Note

- You cannot use DTS Digital Surround decoders not suited to DVD.

Manufactured under license from Dolby Laboratories.
 “Dolby” and the double-D symbol are trademarks of Dolby Laboratories. Confidential unpublished works. © 1992–1997
 Dolby Laboratories. All rights reserved.

9 Other Settings

See page 28 for operation.

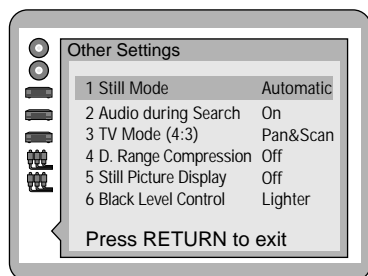

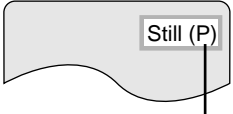
<p>1 Still Mode Select either "Field still" or "Frame still" in the still picture mode.</p>	<p>1 Automatic (Factory preset) 2 Field Select this setting when jittering occurs in the still picture mode when "1 Automatic" is selected. 3 Frame Select if small text or fine patterns cannot be seen clearly in the still picture mode when "1 Automatic" is selected.</p>
<p>2 Audio during Search To select whether audio is heard or not during search (forward direction) at the initial search speed.</p>	<p>1 On (Factory preset) 2 Off</p>
<p>3 TV Mode (4:3) To select whether wide-screen material is played in the pan and scan style or in the letterbox style on a conventional TV (4:3).</p>	<p>1 Pan & Scan (Factory preset) Wide-screen video material will be played in the pan and scan style (the picture is shown with either one or both sides cut off) on a conventional television (4:3). •Video material not formatted in the pan and scan style will be played back in the letterbox style. 2 Letterbox Wide-screen video material will be played in the letterbox style (black bands appear at the top and bottom of the screen) on a conventional television (4:3).</p>
<p>4 D.(Dynamic) Range Compression To compress the dynamic range (the difference between the loudest sound and the softest sound), making it easier to hear dialogue even at low volume. This function only works with Dolby Digital DVD.</p>	<p>1 Off (Factory preset) The dynamic range remains as it was recorded on the disc. 2 On Dynamic range is compressed by increasing soft sounds and reducing loud sounds. Select when viewing discs at low volume, such as late at night.</p>
<p>5 Still Picture Display To display the picture type (DVD), I, P or B in the still picture mode.</p>	<p>1 Off (Factory preset) 2 On</p> <div style="text-align: center;">  <p>Example: P-picture</p> </div>
<p>6 Black Level Control To select the black level of the picture, "Lighter" or "Darker".</p>	<p>1 Lighter (Factory preset) Select when the player is connected to a TV through the VIDEO OUT terminal or S VIDEO OUT terminal. 2 Darker Select when the player is connected to a TV through the COMPONENT VIDEO OUT (Y/P_B/P_R) terminals.</p>

Note

- Audio is heard at any speed when playing CDs, regardless of any settings at "2 Audio during Search".
- Audio is not heard at any speed when playing CDs encoded with DTS, regardless of any settings at "2 Audio during Search".

For your reference

● **I/P/B**

To efficiently store video on DVD, common elements among frames are used in common, and different elements are recorded with each individual frame. The frame that contains the common elements is called an I-picture, a complete frame in itself. A P-picture is calculated from past I or P-pictures. The frame that fills in the spaces between the I-and P-pictures is called the B-picture.

I-pictures have the best picture quality, so they should be used when making picture adjustments.

● **Frame**

Individual images in a video or on the television are called frames.

● **Field**

Half of the video information (video signal) in a frame is called a field. With conventional TV systems, a single frame (a single screen) consists of two fields.

● **Frame still**

The two fields are displayed alternately on the TV screen, so the image may be blurry. However, the image quality is better than field images.















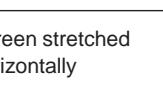
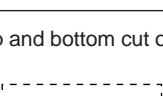
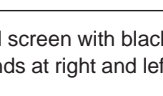

● **Field still**

Only one field (half of the video information) is displayed on the TV screen, so the apparent resolution is low. However, there is no blurring on the screen.

How different kinds of software appear on your television

DVD software is recorded in a variety of picture formats, and how they appear on your TV depends on the software, the kind of TV you have, and the picture mode your TV is set to.

- Letterbox refers to pictures where black bands appear at the top and bottom.
- Pan and scan refers to pictures where part of the picture is cut off so it fills the whole screen.

Television and picture mode Software format	4:3	16:9 full mode	16:9 zoom mode	16:9 auto mode
Wide-screen, pan and scan 	Edges cut off. 	Full screen 	Top and bottom cut off 	Full screen 
Wide-screen, non-pan and scan 	Letterbox 			
Regular (4:3) 	Full screen 	Screen stretched horizontally 	Top and bottom cut off 	Full screen with black bands at right and left 
Regular (4:3) letterbox 	Letterbox 	Letterbox with screen stretched horizontally 	Full screen 	Letterbox with extremities of picture stretched. 

The names given to the television picture modes depends on the make of your television. There may also be slight differences in how the pictures appear on the screen. Refer to your television's operating instructions for details.

Troubleshooting Guide

Before requesting service for this player, check the chart below for a possible cause of the problem you are experiencing. Some simple checks or a minor adjustment on your part may eliminate the problem and restore proper operation.

If you are in doubt about some of the check points, or if the remedies indicated in the chart do not solve the problem, contact your authorized YAMAHA dealer or service center for instructions.

Reference pages are shown as black circled numbers ❸.

Common Problems

No power.	Insert the AC power supply cord securely into the household AC outlet. ❹
The player is automatically switched to the standby mode.	To conserve power, the player is automatically switched to the standby mode after approx. 30 minutes elapsed in the stop mode (Auto power-off function). Turn the power back to ON.
Play fails to start even when [▶ PLAY] is pressed. Play starts but then stops immediately.	Condensation has formed: wait about 1 to 2 hours for it to evaporate. This player cannot play discs other than DVD, Video CD and CD. ❻ DVDs with a region number other than "1" or "ALL" cannot be played. DVDs with multiple region numbers including "1" can be played. ❻ The disc may be dirty and may require cleaning. ❸❸ Ensure that the disc is installed with the label of the side to be played facing upwards. ❹
No picture.	Ensure that the equipment is connected properly. ❶❷ Ensure the television's video input setting (e.g. VCR2) is correct.
No sound. Distorted sound.	Ensure that the equipment is connected properly. ❸–❹ Ensure that the input settings for the television and stereo system are correct. Turn V.S.S. off if it is on. ❶❷
Picture is distorted during rapid advance or rapid reverse.	The picture will be somewhat distorted at times: this is normal.
No key operation (by the player and/or the remote control) is effective.	Some operations may be prohibited by the disc. Press [STANDBY/ON] to switch the player to the standby mode and then back to ON. Alternatively, press [STANDBY/ON] to switch the player to the standby mode, disconnect the AC power supply cord and then reconnect it. (The player may not be operating properly due to lightning, static electricity or some other external factor.)
The picture shown on the television is not normal. (The sides of the picture are cut off or black bands appear at the top and bottom of the screen.)	Go to the initial settings menu "6 TV Aspect" and change the setting to suit your television. You may also need to change the screen mode on the television itself. ❶❷
No on-screen display.	The "Off" setting is selected for "1 On-Screen Messages" in "4 On-Screen Messages": select "On". ❶
On-Screen Menu Icons not displayed or only partially displayed on the TV screen.	Change the position of the On-Screen Menu Icons using "2 Color and Position" in "4 On-Screen Messages" of the initial settings. ❶
The language for the player's menus and on-screen messages is wrong.	Go to the initial settings menu "3 Menu Language" and change the language. ❶
No operations can be performed with the remote control.	To conserve power, the player is automatically switched to the standby mode after approx. 30 minutes have elapsed in the stop mode (Auto power-off function). Turn the power back to ON. Check the batteries are installed with the correct polarities (+ and -). ❶ The batteries are depleted: replace them with new ones. ❶ Point the remote control at the remote control sensor and operate. ❶ Operate the remote control at a distance of not more than 23 feet (7 m) from the remote control sensor. ❶ Remove the obstacles between the remote control and remote control sensor. ❶

DVD

No subtitles.	Subtitles appear only with discs which contain them. Subtitles are cleared from the TV monitor. Display the subtitles. 20 26
Alternative soundtrack (or subtitle) languages fail to be selected.	An alternative language is not selected with discs which do not contain more than one language. In the case of some discs, the alternative language cannot be selected by operating the [AUDIO] or [SUBTITLE]. Try selecting it from the disc's menu if one is available. 18
Angle cannot be changed.	This function is dependent on software availability. Even if a disc has a number of angles recorded, these angles may be recorded for specific scenes only (when "ANGLE" lights up on the player's FL display).
Soundtrack and/or subtitle language is not the one selected at the initial settings.	If the soundtrack and/or subtitle language does not exist on the disc, the language selected at the initial settings will not be seen/heard.
The disc's menu is displayed in French (example).	The setup "3 Menus" of "1 Disc Languages" is set to French: select English.
Sound does not come from a speaker.	Check the connections. 6-18 If you have a subwoofer connected to this player, use the On-Screen Menu Icons with the remote control to turn subwoofer output on. 27 If you have connected this player to an AV amplifier (with built-in decoder) through the digital audio output terminal, go to the initial settings menu "7 Digital Audio Output" and change the settings to "Bitstream" for "2 Dolby Digital" or "3 DTS Digital Surround". 42 Sound will only come from the two main speakers if V.S.S. is on. Turn V.S.S. off. 21 27
The password for rating level has been forgotten. Reset all the settings to Factory Preset.	While stopped, press and hold [◀◀] and [▶▶] on the player and then also press and hold [▲ OPEN/CLOSE] on the player until "Initialized" disappears from the television (after about 3 seconds). All initial settings will return to the default values.
The vocals cannot be turned off.	You have selected an audio channel that includes a vocal channel. Read the disc's jacket to choose the correct channel. 19
A menu is shown after playing each song on a Karaoke DVD.	Most Karaoke DVDs are designed to do this. Some discs have an item in the menu that allows you to play all the songs.

Video CD

No menu play.	This function works only for Video CDs with playback control. 6
----------------------	---

Self-diagnosis display function

When an error or trouble is detected during operation, a message appears in the FL display.
When a message has appeared, check the details given below.

Message	Player status	Remedy
CHECK THE DISC	Disc is dirty.	Wipe the disc clean.
H □ □ □ □ stands for a number.	Trouble is likely to have occurred. The number following "H" differs depending on the status of the player.	Press [STANDBY/ON] to switch the player to the standby mode and then back to ON. Alternatively, press [STANDBY/ON] to switch the player to the standby mode, disconnect the AC power supply cord, and then reconnect it.

● If the message fails to be cleared, even when remedial action is taken, ask a service technician to repair the player.

Choose discs with these marks:



However, do not use irregularly shaped discs, such as heart-shaped. (Discs of the sort can damage the player.)

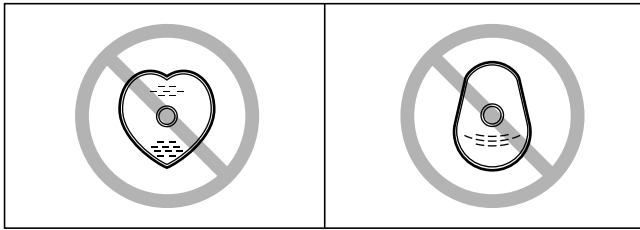

■ How to hold a disc

Do not touch the recorded surface.

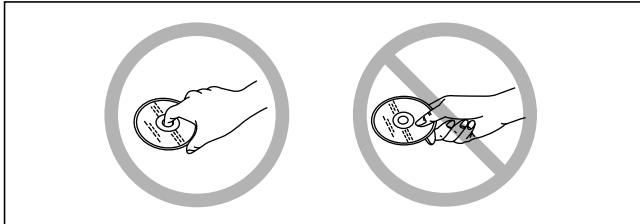

■ If the surface is dirty

Wipe it with a damp cloth and then wipe dry.

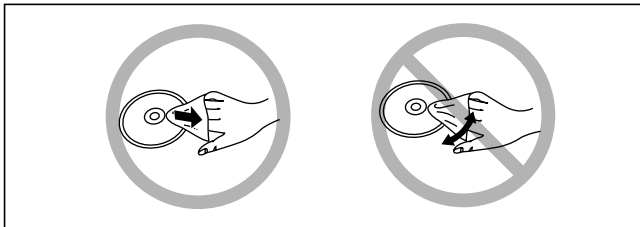

■ If the disc is brought from a cold to a warm environment, moisture may form on the disc

Wipe with a soft, dry, lint-free cloth before using the disc.

■ Handling precautions

- Do not write on the label side with a ball-point pen or other writing instrument.
- Do not use record cleaning sprays, benzene, thinner, static electricity prevention liquids or any other solvent.
- Do not attach labels or stickers to discs. (Do not use discs with exposed adhesive from tape or left over peeled off stickers.)
- Do not use scratch-proof protectors or covers other than those specified for use with this player.

■ Do not place or store discs in the following places

- Locations exposed to direct sunlight
- Humid or dusty locations
- Locations directly exposed to a heat vent or heating appliance

To clean this unit, wipe with a soft, dry cloth.

If the surfaces are extremely dirty, use a soft cloth dipped in a soap-and-water solution or a weak detergent solution.

- Never use alcohol, paint thinner or benzene to clean this unit.
- Before using chemically treated cloth, read the instructions that came with the cloth carefully.

Specifications

Power supply:

U.S.A. and Canada models:	AC 120 V, 60 Hz
U.K. and Europe models:	AC 220–240 V, 50 Hz
Australia model:	AC 220–240 V, 50 Hz
Asia model:	AC 110–240 V, 50/60 Hz

Power consumption:

14 W

Dimensions:

17¹/₈" (W) × 10⁷/₈" (D) × 3⁷/₈" (H)
[435 (W) × 276 (D) × 99 (H) mm]

Mass:

7 lbs. 4 oz (3.3 kg)

Signal system:

U.S.A. and Canada models:	NTSC
U.K., Europe and Australia models:	PAL 625/50, PAL 525/60
General model:	PAL/NTSC

Operating temperature range:

+41 to +95 °F (+5 to +35 °C)

Operating humidity range:

5 to 90 % RH (no condensation)

Discs played:

(1) DVD-Video disc

- 5" (12 cm) single-sided, single-layer
- 5" (12 cm) single-sided, dual-layer
- 5" (12 cm) double-sided, single-layer
- 3" (8 cm) single-sided, single-layer
- 3" (8 cm) single-sided, dual-layer
- 3" (8 cm) double-sided, single-layer

(2) Compact disc (CD-DA, Video CD)

- 5" (12 cm) disc
- 3" (8 cm) disc

Video output:

Output level:	1 Vp-p (75 Ω)
Output terminal:	Pin jack
Number of terminals:	1 system

S video output:

Y output level:	1 Vp-p (75 Ω)
C output level:	0.286 Vp-p (75 Ω)
Output terminal:	S terminal
Number of terminals:	1 system

Component video output:

Asia and Australia models:

Y output level:	1 Vp-p (75 Ω)
P _B output level:	0.7 Vp-p (75 Ω)
P _R output level:	0.7 Vp-p (75 Ω)
Output terminal:	Pin jack

(Y: green, P_B: blue, P_R: red)

Scart video terminal:

U.K. and Europe models:

Audio output:

Output level:	2 Vrms (1 kHz, 0 dB)
Output terminal:	Pin jack
Mixed output (L/R):	1 system
Subwoofer output:	1 system

Audio signal output characteristics:

- Frequency response:
 - DVD (linear audio): 2 Hz–22 kHz (48 kHz sampling)
2 Hz–44 kHz (96 kHz sampling)
 - CD audio: 2 Hz–20 kHz (EIAJ)
- S/N ratio:
 - CD audio: 115 dB (EIAJ)
- Dynamic range:
 - DVD (linear audio): 102 dB
 - CD audio: 98 dB (EIAJ)
- Total harmonic distortion:
 - CD audio: 0.0025 % (EIAJ)

Digital audio output:

Optical digital output:	Optical terminal
-------------------------	------------------

Pickup:

Wave length:	665 nm
Laser power:	CLASS II
Laser output:	Max. 1.0 mW (Continuous)

Power consumption in standby mode:
approx. 2.0 W

Note

Specifications are subject to change without notice.
Mass and dimensions are approximate.

This product incorporates copyright protection technology that is protected by method claims of certain U.S. patents and other intellectual property rights owned by Macrovision Corporation and other rights owners. Use of this copyright protection technology must be authorized by Macrovision Corporation, and is intended for home and other limited viewing uses only unless otherwise authorized by Macrovision Corporation. Reverse engineering or disassembly is prohibited.

YAMAHA ELECTRONICS CORPORATION, USA 6660 ORANGETHORPE AVE., BUENA PARK, CALIF. 90620, U.S.A.
YAMAHA CANADA MUSIC LTD. 135 MILNER AVE., SCARBOROUGH, ONTARIO M1S 3R1, CANADA
YAMAHA ELECTRONIK EUROPA G.m.b.H. SIEMENSSTR. 22-34, 25462 RELLINGEN BEI HAMBURG, F.R. OF GERMANY
YAMAHA ELECTRONIQUE FRANCE S.A. PA PARIS-EST RUE AMBROISE CROIZAT CROISSY-BEAUBOURG BP70-77312 MARNE LAVALLEE, CEDEX 2 FRANCE
YAMAHA ELECTRONICS (UK) LTD. YAMAHA HOUSE, 200 RICKMANSWORTH ROAD WATFORD, HERTS WD1 7JS, ENGLAND
YAMAHA SCANDINAVIA A.B. J A WETTERGRENS GATA 1, BOX 30053, 400 43 VÄSTRA FRÖLUNDA, SWEDEN
YAMAHA MUSIC AUSTRALIA PTY, LTD. 17-33 MARKET ST., SOUTH MELBOURNE, 3205 VIC., AUSTRALIA

YAMAHA CORPORATION
Printed in Japan